

Roll to web processing

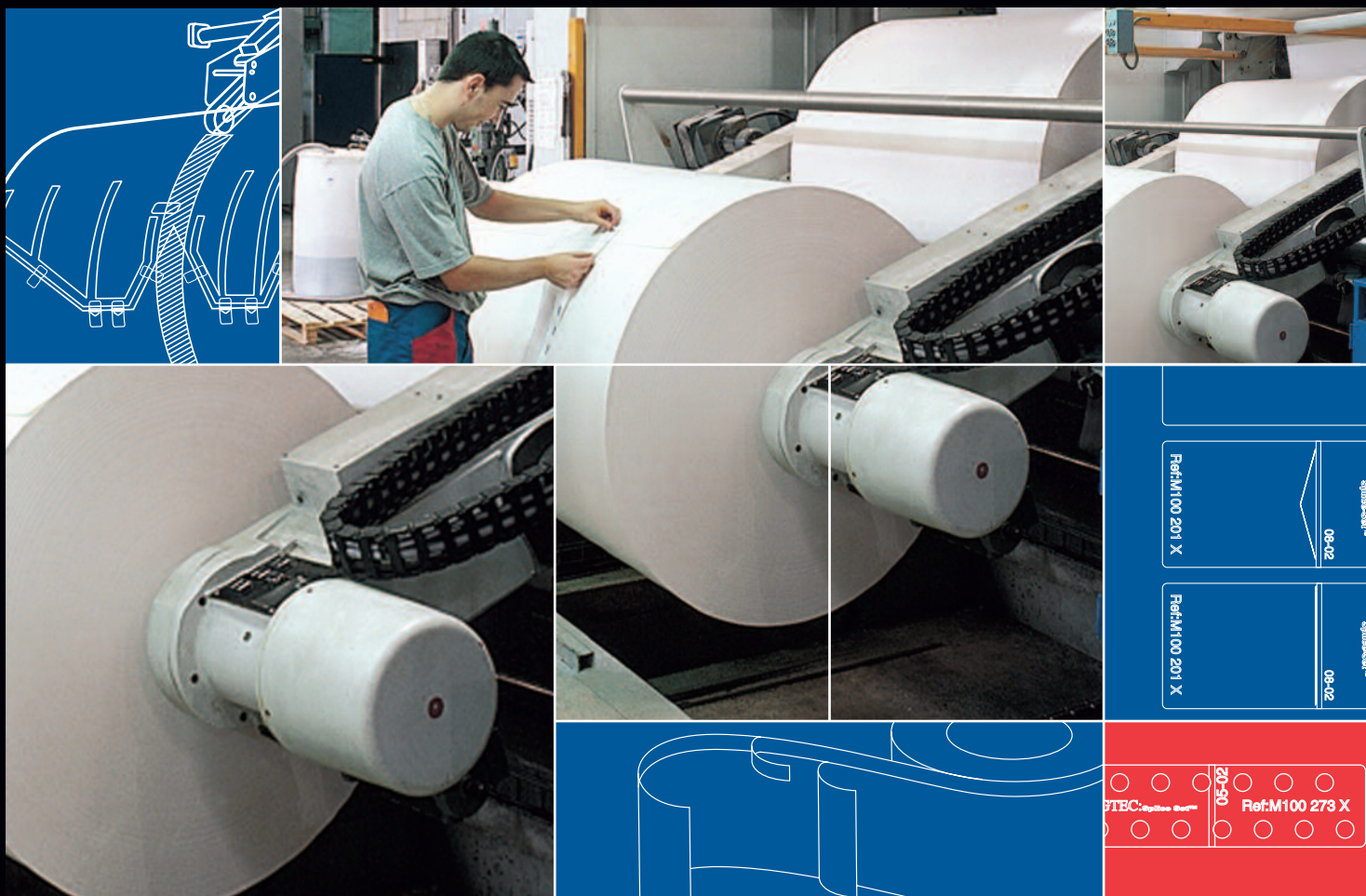



Roll to web processing

Best practice guide for web offset printers

Aylesford Newsprint, Kodak GCG, manroland, MEGTEC, Müller Martini, Nitto, QuadTech, SCA, Sun Chemical, Trelleborg Printing Solutions,

The content and value of this publication have been vastly helped by the assistance of individuals, printers and associations who gave their time and expertise to review and improve this guide.

Special thanks to the leading printers and industry specialists who helped us perfect this guide:

Arnoldo Mondadori Editore, Italy, *Sergio Munarolli*;
GATF (Graphic Arts Technical Foundation), USA, *William Farmer*;
Goldman, Austria;
Grafica Editoriale Srl, Italy, *Attilio Dalfiume*;
Hannan, Australia, *Richard Owen*;
KBA, Würzburg, Germany, *W. Scherpf*;
Maury Group, France, *Jean-Paul Maury*;
Mohndruck, Gütersloh, Germany (Bertelsmann), *Heinz Brontherrm*;
Polestar Petty, UK, *Rick Jones*;
Portsmouth Printing & Publishing, UK, *Ian Baird*;
Quebecor, UK, *Alan Fraser*;
Quebecor Printing PE&E, Canada, *Bill Weiss*;
Roularta, Belgium;
R.R Donnelley & Sons, USA, *Tariq Hussain*;
Southernprint, UK, *Dave Budden*;
St. Ives Plymouth, UK, *Jerry Westall/Charlie Pett*;
Transcontinental Printing Inc., Quebec, Canada, *Bob Erbstein*;
Treasure Chest, US, *Donald Brumfield*;
Tusch Druck GmbH, Austria, *Hans-Christian Harnisch*.

Principal contributors :

AYLESFORD NEWSPRINT, *Mike Pankhurst*;
BUTLER Automatic, *André Naville*;
MEGTEC Systems, *John Dangelmaier*;
manroland, *Arthur Hilner*;
NITTO, *Bart Ballet, Michel Sabo, Pierre Spetz*;
SCA, *Marcus Edbom*;
SUNCHEMICAL, *Larry Lampert, Gerry Schmidt*.

Other contributors :

Donald Dionne; Norske-Skog, *Simon Papworth*; UPM-Kymmene, *Erik Ohls*;
Sinapse Graphic International, *Peter Herman*.

Special acknowledgement to

PIA and WAN-IFRA for their assistance and permission to reproduce some of their material.

Managing Editor *Nigel Wells*.

Illustrations by *Alain Fiol*

Design and prepress by *Cécile Haure-Placé and Jean-Louis Nolet*

© August 1998, January 2002. All rights reserved. ISBN N° 2-9518126-1-2
Guides are available in English, French, German, Italian and Spanish editions.

To obtain printed copies in North America contact PIA printing@printing.org
In other areas contact your nearest Web Offset Champion Group member
or weboffsetchampions.com

Bibliography, contacts and recommended reading

PIA : USA

"Solving Web Offset Press Problems",
5th edition, 1997
printing@printing.org

WAN-IFRA, Germany :

"Newsprint and Newsink Guide" ;
"Runnability and Printability of Newsprint"
Special Report 1.16,
"The performance of newsprint in newspaper production"
Special Report 1.18
wan-ifra.org

IDEA alliance, USA:

"Specifications for Web Offset Printers"
idealliance.org

"Wrapping of Paper Reels"

Nordic Paper Group for Distribution Quality

Roll to web processing is not only the start of the printing process but also paper is its largest expense (50-70% of total operating costs) making it essential to minimise waste from all causes. IFRA states that "often roll preparation produces such surprisingly high and unnecessary amount of waste that the productivity of the entire printing press can be affected. Any miss-splice, following a careless preparation, or any web break due to an inaccurate check of the roll will cause a long production interruption with the corresponding consequences. The successful preparation of the splice greatly depends on the skill and experience of the staff."

This guide has been prepared for press room staff to provide them with a useful aid in their daily work with both flying paster and zero speed splicer technologies.

To achieve consistent splice efficiency of over 99% requires (a) optimum combination of tape and tab qualities; (b) correct splice preparation; and (c) a paster maintained and operated to ensure an efficient splice cycle. Many runnability problems are also directly related to poor roll storage and handling, temperature and humidity variations.

The purpose of this guide is to provide heatset and coldset web offset printers with a base reference to best practice as a tool to improve overall performance. The contributing companies play a role in an inter-related production chain and the combination of their expertise is a positive way to help improve overall process performance:

- Avoidance of predictable problems.
- Correct use of materials and equipment.
- Systematic problem diagnoses with appropriate remedial actions.

IMPORTANT NOTE :

A general guide cannot take into account the specificity of all products and therefore we recommend that it is used in addition to information from your suppliers, particularly the manufacturers of equipment whose safety, operating and maintenance procedures must take preference over the contents of this guide.

To assist readers we have used a number of symbols to bring attention to key points :



Best practice



Poor practice

Consequences of poor practice:



Avoidable cost
(waste, time, etc.)



Safety

CONTENTS

Web offset paper grades	4
Ink-paper relationship	5
Roll to web processing system	6
Common problems	7
Web tension	8
Humidity and temperature	9
The paper roll	10
Roll handling and storage	12
Paster & Splicer characteristics	14
Splice pattern selection	16
Splice tapes and tabs	18
Splice tails	20
Paster make ready	21
Roll to web processing steps	22
Best practice preparation	23
V&W patterns	26
Straight pattern	28
Zero speed	30
Key preventative maintenance for pasters and splicers	31

∅ : diameter
> : more than
< : up to
m/s : metres per second
fpm : feet per minute
PSA (Pressure Sensitive Adhesive) double sided splice tapes.
Paster and splicer :
 When discussing common areas between the two techniques we have used both **«paster»** or **«splicer»**, when the subject is specific to one design we use the full name **«flying paster»** or **«zero speed splicer»**.

Web offset paper grades

CODE	NAME	SURFACE	GSM	BASIS #	MOISTURE
NP	Newsprint	Uncoated	40-48,8	26-30	8-10%
INP (MF)	Improved Newsprint	Uncoated	45-60	28-40	"
TD	Telephone Directory	Uncoated	28-42,5	23-26	"
SC-A	Super Calendered	Uncoated	45-65	33-43	5-6%
SC-B	Soft Calendered	Uncoated	45-65	33-43	"
MFP	Machine Finished Pigmentised	Pigmentised	54-70	36-47	
MFC	Machine Finished Coated	Matt coated	54-70	36-47	
LWC	Light Weight Coated	Coated	36-80	24-54	4-6%
ULWC	Ultra Light Weight Coated	Coated	36-48	26-28	"
MWC	Medium Weight Coated	Coated	80-115	54-77	"
WF	Woodfree	Uncoated	80-150	54-101	"
WFC	Woodfree Coated	Coated	80-150	54-101	"

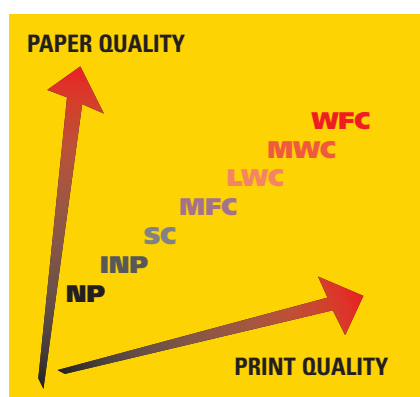

1

The different grades are manufactured to conform to variable customer requirements of cost, print quality and runability. Optical properties are generally defined by brightness, shade and opacity. Most web offset papers are a blend of two types of pulp to provide a paper with a balance of properties and value. Mechanical pulp provides good opacity but has low brightness and relatively weaker fibre strength. Chemical pulp provides stronger fibres and higher brightness but has lower opacity.

Some papers are produced to specifically suit either the gravure or offset production process. Each type has significant differences of surface strength and absorbency and their use is not normally interchangeable e.g. a gravure grade printed offset will have less strength than offset, often exhibits surface piling and difficulties with dampening/ink interaction.

The minimum moisture content for printing is around 3%. Below this point paper will cause high static electricity with possible interference to press electrical equipment, missed splices and difficulties with folding and offline finishing.

All grades can contain a percentage of recycled fibre. This does not significantly effect the physical or optical properties of these papers except that they may be more dense and heavier for a given roll diameter.

Paper qualities

Paper making is a vast and complex process which produces a substrate to very fine tolerances and ever increasing overall quality. Nevertheless, it is primarily composed of natural cellular material which by their nature can be locally variable (unlike synthetic products such as plastic film which have continuous predictable qualities).

The specifications of a grade (or individual paper) cannot completely predict its print-ing performance qualities. Paper performance on presses of the same model may vary because of different running conditions (cylinder setting, blanket type, packing, humidity, temperature, etc.).

To ensure consistent quality, paper mills rigorously test a wide range of properties. However, laboratory tests can only provide the paper maker with an indication of consistency/ conformity and may not always accurately predict press performance and print quality.

1- Relationship between paper quality and perceived print qualities.

Ink-paper relationship

Paper & ink selection chart

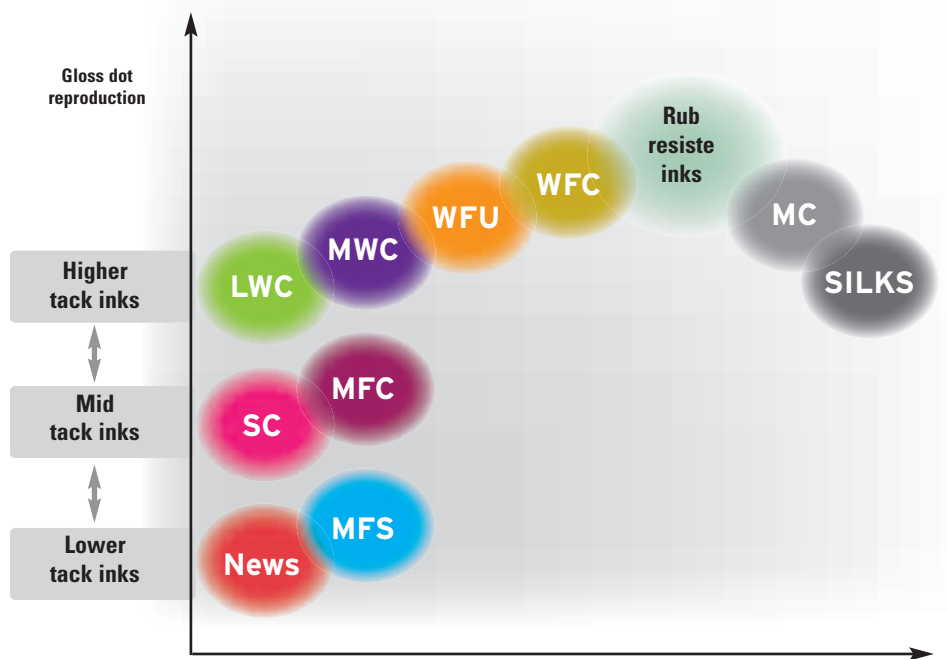

Ink types are similar to paper grades in that each is manufactured to conform to user requirements of print quality, flexibility and cost. Ink selection starts with the paper grade.

Ink consumption on different paper grade

Ink consumption is variable in relation to the paper surface because ink sits upon the coating of LWC but sinks into the body of the paper on more absorbent surfaces like Super Calendered (SC) and newsprint. Ideally each paper should be printed to its maximum density rating. However, in practice many customers require more colour depth leading to higher ink film weights on some papers. Tests show that running a density of 1.3 on different paper grades substantially increases ink film weight and that film weight varies considerably within LWC and SC grades. This chart shows the % extra ink required to achieve a density of 1,3 on different papers; it also shows that ink consumption can be highly variable within the same grade of paper.

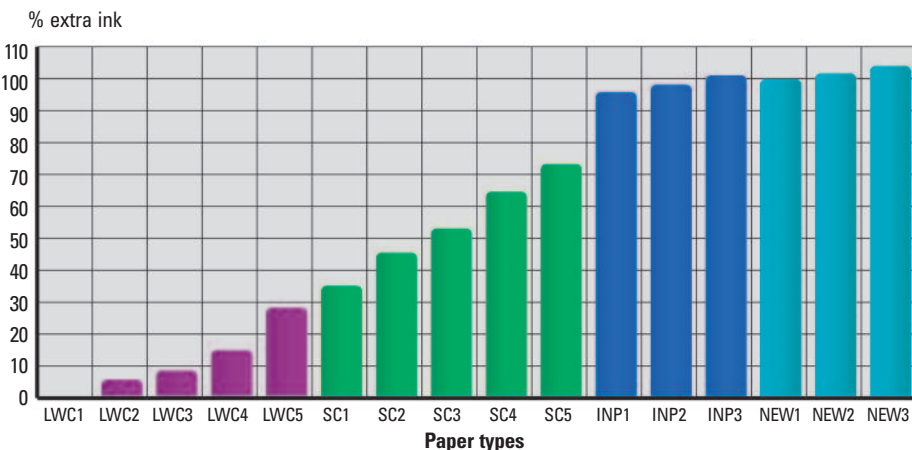

Best practice is that printers should be supplied with print density, Tone Value Increase (TVI) and contrast specifications on proofs which are compatible to the paper surface to be printed.

Roll to web processing system

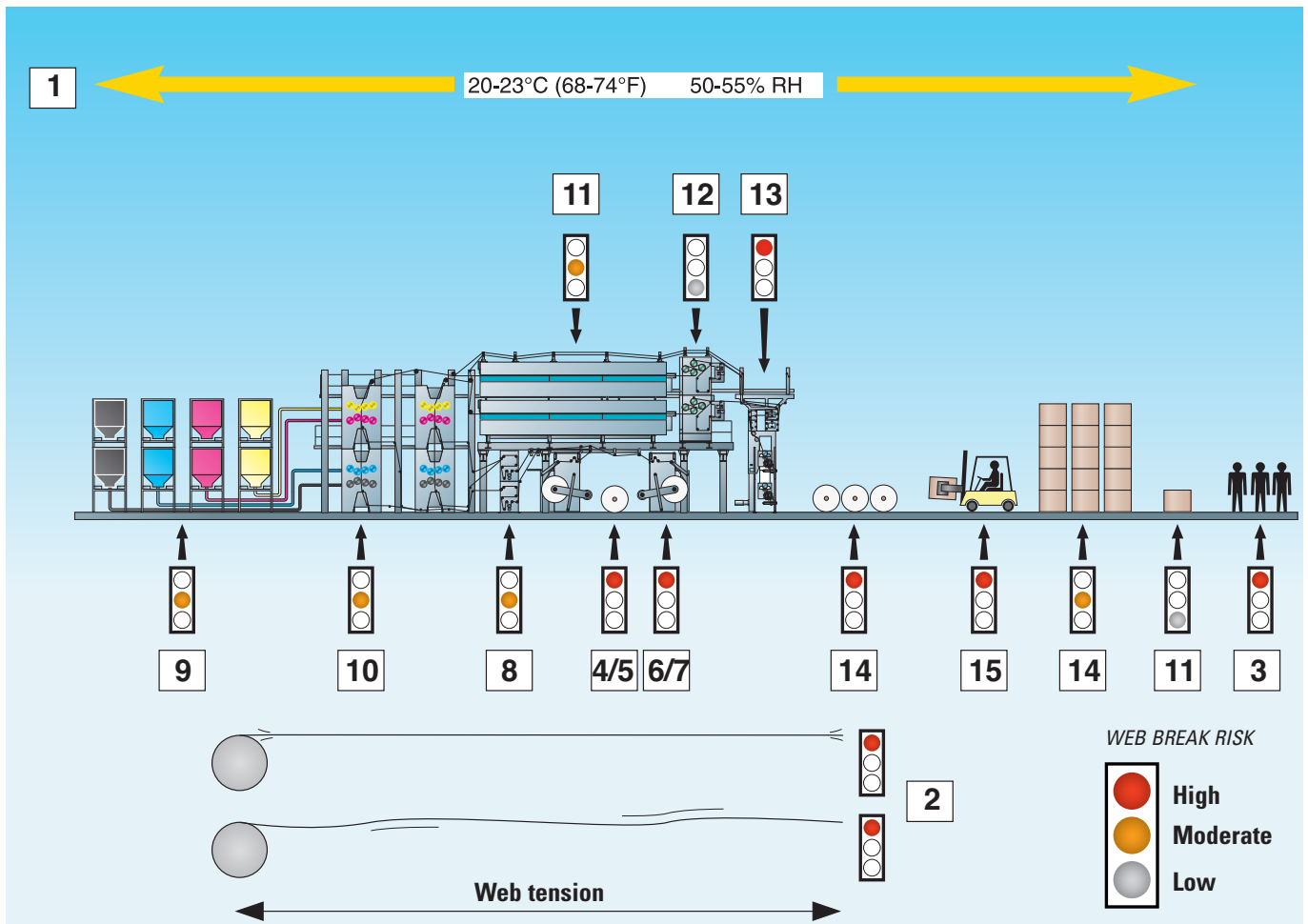

 The press, its environment, materials, maintenance and operating staff constitute a system in which several elements have an impact on roll to web processing and all can impact on web breaks. Some elements apply to the entire system, e.g. web tension and ambient operating conditions; others are more specific to one components but the behaviour of which frequently influences others.

KEY SYSTEM ELEMENTS	WEB BREAK RISK*
1 Temperature and humidity	High
2 Web tension throughout line	High
3 Operating and maintenance staff competencies & training	Moderate-High
4 Manual roll and paper handling	High
5 Automated roll and paper handling	Low
6 Splice preparation	High
7 Paster	High
8 Infeed and web guide	Moderate on web breaks
9 Ink and water	Moderate on web breaks
10 Press units	Moderate on web breaks
11 Heatset dryer	Moderate on web breaks
12 Chill roll tower	Moderate on web breaks
13 Folder	High on web breaks
14 Paper storage	Moderate-high on web breaks
15 Roll handling	Moderate-high

* Web break risk level may vary from plant to plant. See also Guide N°2: "Web break prevention & diagnostic".

Common problems in roll to web processing

PROBABLE CONSEQUENCES

Splice preparation	Burst	Fail	Mis	Break	Flying	Zero
1 Failed roll fault inspection prior to loading		●	●	●	○	○
2 Rolls unwrapped too early	●	●	●		○	○
3 Excessive vibrations		●	●	●	○	○
4 Wrong roll unwind direction (flying paster)		●			○	
5 Incorrect splice pattern type		●	●		○	
6 Splice pattern bursts open before splice					○	
Air pockets	●				○	
Dynamic roll expansion (see also 2)	●				○	
Rupture tabs applied too tightly	●				○	
Open tape in acceleration belt path	●				○	
Too fast acceleration tears paper			●			○
Splice shields not fully closed or no vacuum		●				○
7 Failed splice					○	
Inadequate splice tape pressure		●			○	
Uneven tape profile from overlaps		●			○	
Tape protective strip not removed/No tape applied		●	●		○	○
Dust, moisture, solvent on open splice tape		●			○	○
Glue unsuitable (tack, temperature, humidity)		●			○	○
Cold roll (temperature near core below 10°C)		●			○	○
Rupture tabs incorrect or turned over covering detection tab		●	●		○	
No splice detection tab, sensor dirty		●	●		○	
8 Tape or glue overlaps edge of roll			●		○	○
9 Tabs come loose and stick to expiring web or blanket			●	●	○	
10 Splice detection tab in wrong position		●	●		○	
11 Tab in path of folder slit			●		○	
12 Too long paster tail causes folder jam			●		○	
13 New roll not aligned to expiring roll or variable roll widths			●		○	○
14 Cocking roller setting incorrect			●	●	○	○
15 Zero speed splicer incorrect alignment to nipping roller		●	●			○
16 Setting and maintenance (see page 59)	●	●	●	●	○	○

Splice faults & web breaks

During the splice cycle there will be a change in tension profile and any weak spots in the web or splice will be subjected to extra stress and a web break or splice failure may occur.

Burst splice

When the new roll bursts open prior to splicing.

Failed splice

When the new roll does not paste to the expiring web.

Missplices

Any failure of the splice during the cycle from when the splice arms start to move (or zero speed festoon begins to fill) to the moment the splice leaves the folder; without disturbing the web, causing a press stop or excessive waste.

Web breaks

Usually occur when press tension variations become excessive and coincide with local area weaknesses in the web. Web wander, web touching (in the dryer) and blanket tack-out are other web break causes.

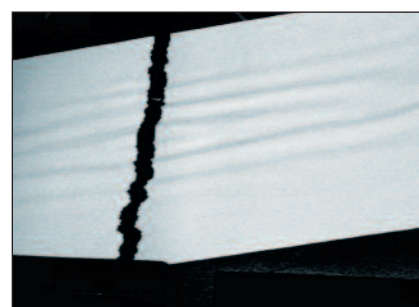

High speed photograph of a web breaking.

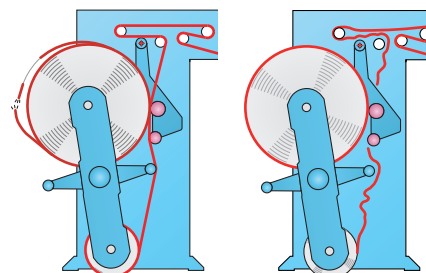

Burst splice.

Failed splice.

Web tension is a fundamental key to total press efficiency

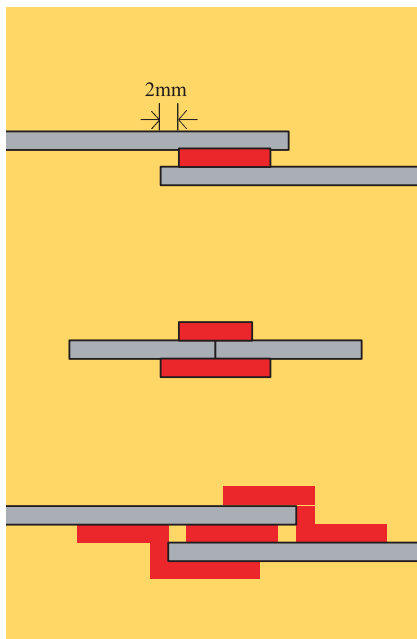
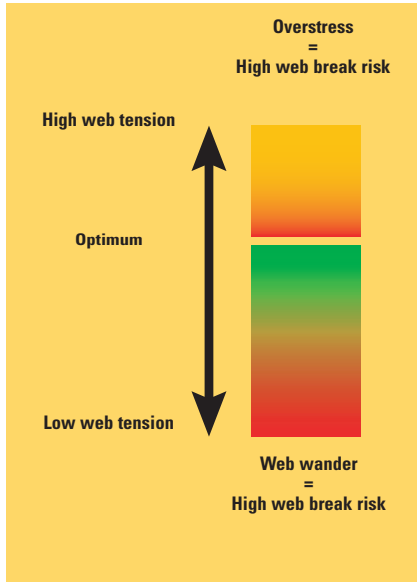

1

Optimum web tension is fundamental for colour quality and high productivity. It impacts on waste and available press time.

Poor tension can cause web breaks, web flutter, loss of folder register and jams, loss of colour and back-up register, image slur.

Tension variations come from (a) paper (b) press line (c) poor working practices. Web breaks occur when either tension variations become excessive, and/or there are local area weaknesses in the web.

a Paper and roll characteristics

Modern paper mill winders run at speeds up to 50 m/s (8000 fpm) on webs over 9 m (30') wide. To obtain a good and even winding it is important to have even profiles of moisture, hardness and tension.

Mill join splices are made after a web break or to make fillings (joining two tambour reels to fit customer diameters). These joins have become extremely reliable and can be made in several ways. Mill joins should be coloured to allow photo cell detection and physical separation and should not be closer than 70 mm (2,75") to the core to avoid any disturbance to the splice cycle and tension. (Tambour is also known as mother roll or jumbo roll).

Paper is primarily composed of natural cellular material which by their nature is locally variable. «Every cm of roll length will not react to a given stress in the same way» (WAN-IFRA). There will always be some variation in tension profile in all papers from all suppliers. It is normal that there are variations of tension (1) across the width of the paper making machine, consequently a variation from roll to roll and (2) between the surface and core layers, (3) at mill splices near cores.

To minimise roll to roll tension variations some printers organise their internal paper storage to deliver to the press rolls from the same position in the tambour. This practice is claimed to provide lower tension variations between rolls during splicing and running, providing waste reduction and reduced creasing, particularly on heavier papers. The roll position is contained in the roll number. Many mills print this position on the label when requested. It is best to use position numbers within an order and not mix orders, as the positions do not always match exactly between orders.

Local paper making weaknesses which may cause web breaks include poor mill splices, creases and hair cuts which create weak spots which may not resist the tensions applied to the web. See *Guide N°2 Web break prevention & diagnostic*

b Web tension variations from press line

Equipment which influences tension includes:

Type of paster and infeed, variation at printing units (cylinder pressure setting, blanket type/packing), automatic blanket washers, dryer, chill rolls and folder. During the splice cycle there will be a change in tension profile. If there are any weak spots in the web or splice they will be subjected to extra stress and a web break or splice failure may occur.

c Poor working practices

Lack of on-going training and motivation often results in incorrect setting, operation and maintenance of equipment. Poor roll handling can damage and deform rolls (e.g. out-of-round rolls unwind unevenly creating excessive variations of web tension with every revolution).

The correct infeed tension setting is 5-10 times lower than the breaking tension of the paper. A frequent cause of avoidable stress to the web is failure to change tension setting when reducing paper weight or web width. This can lead to tension settings 2-4 times higher than they should be.

1- Commonly used types of mill join splices.

Humidity and temperature impact on production

	HIGH %RH	LOW %RH	LOW TEMP.	HIGH TEMP.
Burst splice risk	●			●
Splice failure risk	●	●	●	●
Web break risk	●	●		
Brittleness		●		●
Piping*	●			
Shrinkage		●		●
Static electricity		●		●
Extra printing waste	●	●		

*Piping occurs in <10 outer layers and increases risk of creasing.

Paper rolls

Paper cannot be made to suit all pressroom temperature and humidity conditions and will take up and give up moisture immediately after unwrapping, depending upon the disparity between it and the surrounding air. Paper stability is achieved at 20°C to 23°C (68-74°F) and 50-55% relative humidity. The most important parameter to keep under control is humidity.

- Keep the protective roll wrapping on as long as possible to minimise risk of damage and the negative effects of atmospheric humidity and dynamic roll expansion. The open time of prepared rolls is determined by the grade of paper, the relative humidity (often variable during the course of a day and by season) and time. The combination of these factors should be monitored to establish the number of rolls that can be prepared in advance under the conditions prevailing in your plant.
- Store the paper in the pressroom for a few days before use if (a) there is a significant difference in temperature and humidity between the pressroom and paper storage area, or (b) if rolls are delivered directly to the pressroom from the paper supplier. In extremely cold winter conditions, paper can take up to two weeks to achieve ambient temperature throughout the roll. The outer layers of paper warm up relatively quickly, but the paper close to the core (splice area contact point) can take two weeks to obtain an ideal minimum splicing temperature (min.15°C/59°F). Below this temperature there is an increasingly high risk of splice failure.

Tapes & tabs

Adhesive properties are influenced by temperature and humidity. Different adhesive formulations are available to deal with some variation in temperature and humidity.

- Select tape type in relation to ambient temperature and humidity in your plant.
- Store tape in its original packaging at a temperature between 15- 35°C (59-96°F) with a relative humidity of max. 70% and away from direct UV exposure. Respect the «use by date» as adhesive qualities deteriorate over time. Leave protective liner on tape as long as possible.
- Cold conditions: Store the tape in the original packaging at ambient pressroom temperature at least one day before use. Special lower temperature PSA tapes are available.
- High humidity conditions: Use a high humidity tape and ensure it is kept cold (in a refrigerator) except when being used to prepare a splice.



Preparing splice patterns of several rolls in advance may increase risk of the splice pattern breaking open, as unwrapped rolls take up moisture quickly in the outer spires (layers). This increases the risk of creasing and expansion and can burst the splice pattern. Keep the protective roll wrapping on as long as possible. Taking the end shields off too early can cause roll edges to dry out or absorb moisture resulting in a visibly skewed profile as the web leaves the roll.

The paper roll

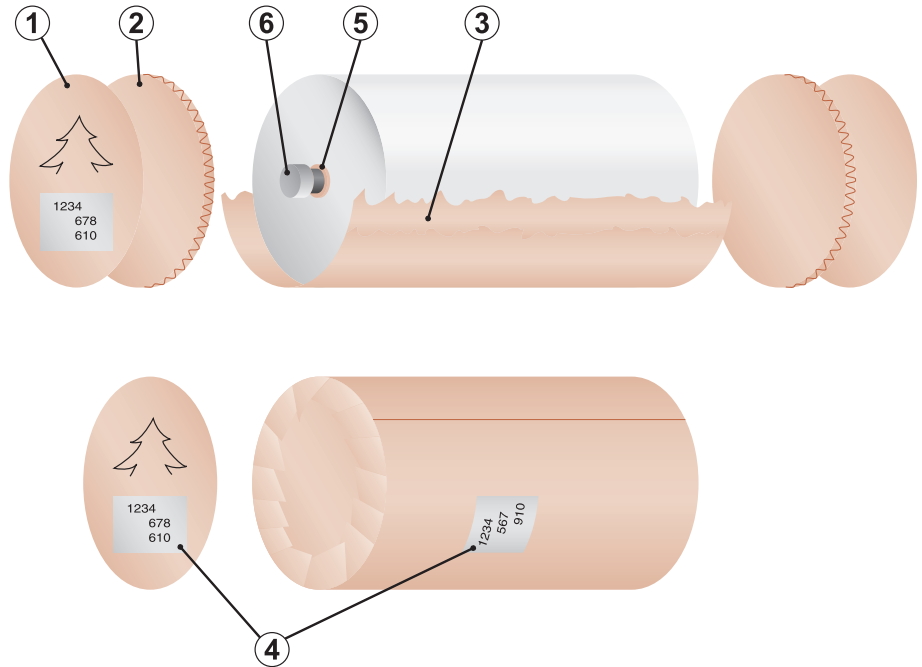

- 1 - Outer end shield, with moisture barrier
- 2 - Inner end shield
- 3 - Belly wrapper with moisture barrier
- 4 - Label & Bar-code
- 5 - Core
- 6 - Core plug

Roll core

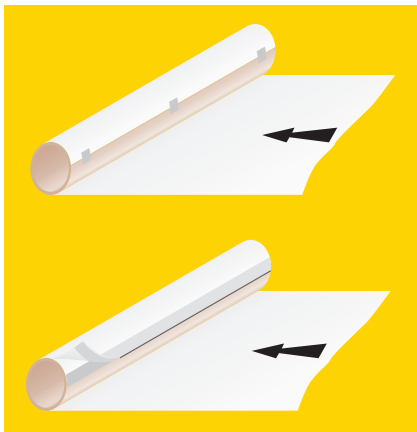

1

Most pasters now use core braking and acceleration. Therefore the transfer of torque is dependent upon (a) the method of roll support to firmly lock the roll without slippage (including emergency stops) (b) core quality (c) and securely attaching and winding the paper on to the core. The core is used to carry the paper web and must be of sufficient strength and stiffness to prevent crushing in normal handling, delamination during printing and avoid vibrations from the core centre on high speed presses.

Core ends can be plain, or have slotted or metal inserts. The use of cores with metal ends and/or slots has almost disappeared in Europe due to the current high qualities of cores and paster chucks. Core plugs are also in declining use because improved core qualities have made them redundant as well; plus the use of automatic unwrapping lines. In the Americas there is still a wide range of cores with metal tips, but this is in gradual decline.

The most common core internal \varnothing is 76,2 mm/3" (+1 mm/-0 mm).

Wall thickness (and external \varnothing) may vary depending upon roll weight and manufacturer.

Roll dimensions

Width ± 3 mm ($\pm 0,12$ ") to web width specified (width 1000-2000 mm, 40-80")

Out-of-roundness is the result of poor handling and storage. These rolls may be unwound on pasters but production speed may be affected. The high vibrations from running out-of-round rolls may make splicing very difficult or even impossible.

1- Common methods of attaching paper web to the core.

The wrapper function

- Protect the roll against mechanical handling, moisture, light and dirt.
- Maintain the manufactured moisture content in the paper.
- Prevent product from being unrolled.

When unwrapped the roll acts like a released spring and will tend to loosen. This phenomena will put additional tension on to splices prepared in advance. Cold rolls tend to expand more when warming up.

Label information

- Producer
- Brand name/paper grade
- Mill order number and/or customer order No
- Roll number
- Grammage/Basis weight
- Weight
- Linear length
- Width
- Bar-code(s) preferably on white background

Bar Codes

Bar codes are a fast and efficient method of recording roll data.

Today there are a large number of systems using different ways to present information.

Work is underway to try to establish a common industry standard for Europe and North America.

Unwrapped roll ends

Some paper rolls are marked with inkjet on the ends.

This information varies from supplier to supplier, it commonly includes:

- Roll number
- Grammage/basis weight
- Unwinding direction
- Mill splice position

These markings ensure that the roll is loaded onto the paster with the correct unwind direction, and to make it possible to track part rolls that have been removed from the paster (Mill joins should also be coloured to allow photo cell detection and physical sorting).

Storage of part rolls

Partly used rolls which are returned to storage should be protected from damage and atmospheric changes with a wrapping capable of withstanding minor bumps and acting as a moisture barrier. They should have the original roll label re-attached or the roll number written on, with gsm, grade/brand. Part rolls should be used at the earliest opportunity to maximise warehouse space and avoid deterioration.

 **Separated waste**
= higher value payment for recycling & environmental best practice

- Brown waste (end covers, wrapper)
- Fibre core (strip off white waste)
- White waste from slab off, core
- Printed waste



1



2

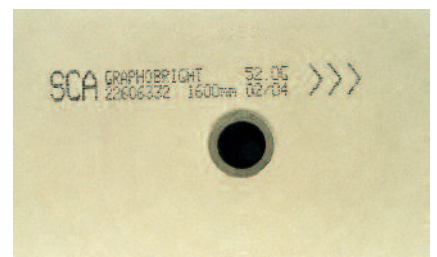

3

1- Dynamic roll expansion after wrapper removal.

2- Typical roll label.

3- Markings on unwrapped roll ends.

Roll handling and storage

Prevention of handling and storage defects will result in less physical damage to the paper and minimise paper losses and production difficulties from deformed rolls and local paper weaknesses on the edges and surface.

Transport-delivery

Rolls should be positioned vertically (standing on end) during transport to avoid distortion. If rolls are transported on their sides then adapted delivery ramps are required for unloading.

Inspection on delivery

- Rolls should be inspected upon arrival and any visible defects should be noted on the delivery documents. Digital cameras can be used to document damage and to send by E-mail to those needing this information.
- Failure to note damage on the delivery documents could result in any claim for damaged paper being rejected. Neither does it allow fault analysis to be made to isolate and resolve cause of damage.

Storage

- The warehouse should have these attributes:
 - Dry
 - Clean
 - Even / level floor
 - Have sufficient working space
 - Good lighting
 - Roll bay markings on the floor
 - Storage temperature should be similar to the pressroom. Minimum 15°C (59°F)
- Rolls should be:
 - Stacked on their ends, evenly in straight lines, with same unwind direction
 - No overlapping
 - Outer rolls protected with roll guards
 - Use paper on «first in, first out» principle
- Damaged rolls which may require excessive stripping and paper waste before running
- Deformed rolls which may reduce press running speed and splicing efficiency
- Rolls which cannot be run at all

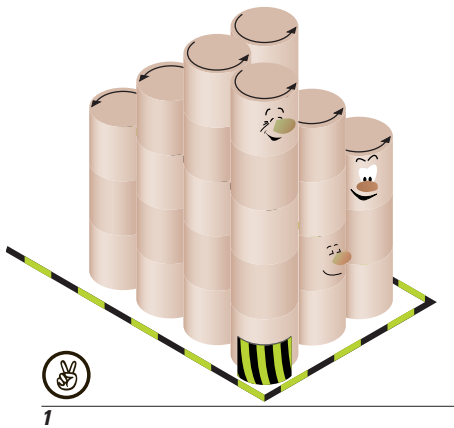

1

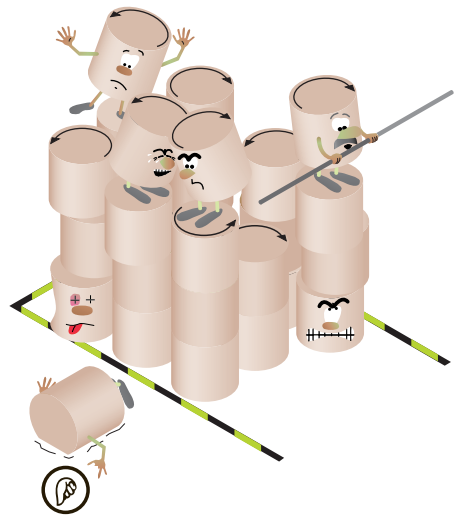

2

1- Correctly stacked rolls.
 2- Poorly stacked rolls.
 3- To minimise roll to roll tension variations, some printers organise their internal paper storage to deliver to the press rolls from the same position in the tambour (which is marked on the label). This practice is claimed to provide lower tension variations between rolls during splicing and running, providing waste reduction and reduced creasing, particularly on heavier papers.

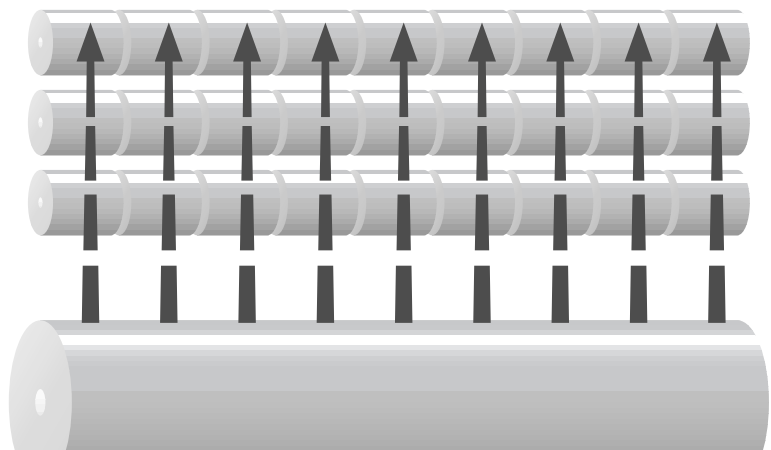

3

Handling equipment

-  • The correct equipment and handling procedures must be employed to maintain rolls in the best possible condition.
- Lift truck capacity must be suitable for the rolls being handled.

-  • Using the wrong equipment can be a danger to personnel.

-  • Poor handling and storage will result in more damage to rolls, higher waste levels and increased risk of web breaks during production.



Correct use of lift trucks

-  • Ensure the mast is vertical.
- Clamp the roll in the middle.
- Lift the roll before moving.
- Ensure sufficient ground clearance before rotating roll.
- Stop before releasing the roll.
- Handle only the number of rolls for which the lift truck is intended.
- Use split arms when handling more than one roll at a time (including multi packs).

Clamp blades

-  • Keep the surface clean.
- Inspect clamp blades daily.
- The corners and edges should be well rounded.
- Grind smooth damaged edges.
- Some printers attach high density foam pads to the metal clamps to act as a cushion.

Clamp pressure

-  • Lifting capacity depends on friction between clamp-wrapper-roll.
 - Always adjust clamp pressure to roll weight and paper quality.
 - Check clamp pressure regularly, keep a record.
-  • Too low a pressure may result in dropped rolls.
 - Too high a pressure may result in deforming rolls out-of-round.

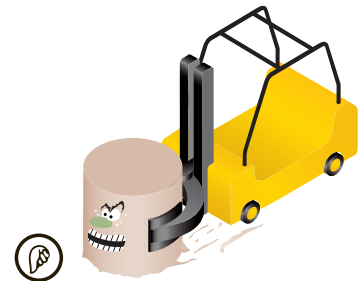

1

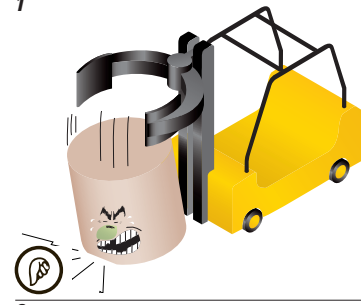

2

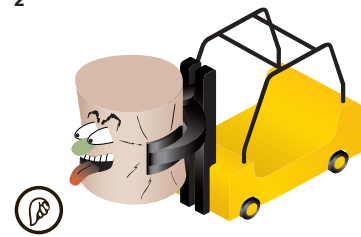

3

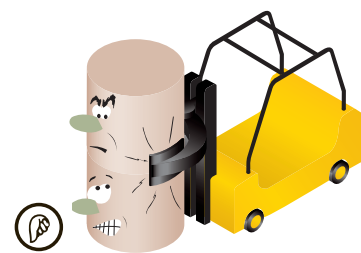

4

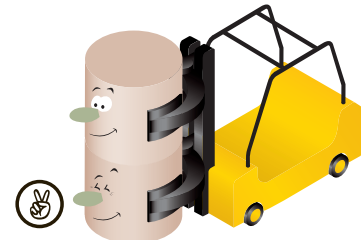

5

- 1- Lift the roll before moving.
- 2- Stop before releasing the roll.
- 3- Adjust clamp pressure to roll weight and paper quality.
- 4- Use split arms when handling more than one roll at a time.
- 5- Check clamp pressure regularly.



5

Pasters & splicers characteristics

Functional requirements of pasters and splicers to convert rolls into a continuous web

- 1 Load and support the roll
- 2 Deliver continuous web to press by splicing from roll to roll at full press speed
- 3 Unwind the paper web at the speed required by the press

Key qualities of the splice and roll change process

- Maintain tension and lateral position (in relation to press, infeed, web guide)
- Minimise web breaks, splice failures (press down time and waste)
- Minimise paper running waste

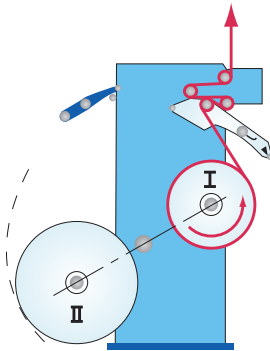

Fig A

Types of pasters

There are two technologies:

Flying pasters and zero speed splicers. As there are a number of variations to these basic designs, this guide must be read in association with the operator's manual(s) of the specific pasters and splicers in your plant.

The main difference between the two technologies is that a zero speed splice occurs when the web is stationary (but the press runs at full speed) and a flying splice which occurs at the matched speed of the press.

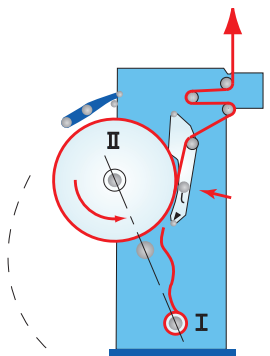

Fig B

Flying paster

The splice cycle

A The first roll is being unwound, the new roll is loaded and splice pattern prepared. An automatic splice cycle starts about 2 minutes before splice when a klaxon/flashing light inform the press crew. The cycle can also be manually started by the operator.

B The arms are rotated into the splice position, the splice arm carriage pushes the running web to about 10 mm (0,4") from the new roll surface. The new roll is accelerated (by either a belt on the roll circumference, or by a core drive) to match the speed of the running roll ($\pm 0,5-1\%$). The new roll should be aligned to the running web ($\pm 1 \text{ mm}/0,04''$).

The PLC synchronises all splice parameters (running web speed, minimum roll \emptyset at splice, new roll circumference, speed, position of detection tab) and automatically triggers the splice:

The running web is pushed by (roller or brush) against the surface of the new roll about 1500 mm (60") before the splice pattern, the roll is pasted on to the running web and the perforated tabs burst open to release the new web.

- The knife cuts the web of the expiring roll just after the end of the splice pattern (splice tail).
- Tension control brake transferred is to the new running roll.
- The expiring roll is braked to a halt and the splicer carriage returns to its home position.

C The arms are rotated into the running position.

- The expired roll is removed and new roll loaded.
 - Pastors with automatic loading systems often have an option to rewind the tail of the expired roll.
- There are a large number of flying paster designs, however, they all have a similar splice cycle, the main differences are in the way rolls are supported, rotated, accelerated and braked. Splice patterns may be straight, V or W.

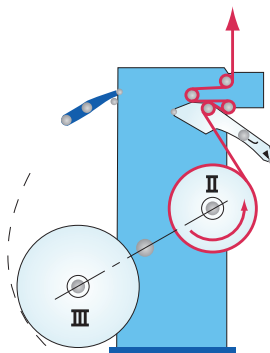

Fig C

Zero speed splicer

The principal design differences between different models are:

Festoon

Vertical configuration provides simple braking, acceleration, control, easy web-up and minimum floor space. Horizontal designs offer no functional advantages, are more complicated and difficult to web-up but they may be lower in height.

Roll position

Roll-over-roll (RoR) with a vertical festoon occupies a minimum floor space but loading upper roll needs an overhead hoist; central loading twin webs are common. Horizontal Roll-beside-roll (RbR) designs are easier to load (but usually still require either a hoist or lift table) but occupy more floor space and are mostly suitable for single web presses.

Splice head

Rubber coated rolling nip splice bars are the most common. Higher performance models have a one step operation.

Makeready

The first roll is loaded and then webbed up through (a) the splice head, (b) the accelerator pull roller (some models may have belt or core acceleration), (c) the festoon dancer assembly via the corridors between the fixed fingers and the dancer rollers (nested design).

The splice cycle

The dancer assembly moves upwards to create a festoon of paper. During running the festoon is maintained by a web brake at a low level to minimise web wander.

A The new roll is loaded and its web is led to the splice head and splice is prepared.

An automatic splice cycle starts about 2 minutes before splice when a klaxon/flashing light inform the press crew. The splice cycle can also be manually started by the operator.

B Just prior to the splice cycle the festoon rises to its highest position to store the maximum length of paper.

C The splice cycle starts by braking the running roll to a stop which then activates:

- The nip brings the running web into contact with the adhesive tape on the new roll lead.
- The knife cuts the web of the expiring roll
- The paper stored in the festoon maintains a continuous paper supply to the press during the splice cycle. The length of paper required is determined by the press speed which dimensions the distance and number of rollers in the festoon.

D The splicer head retracts and the roll is accelerated to the press running speed.

The expired roll is removed.

All zero speed designs have a similar splice cycle.

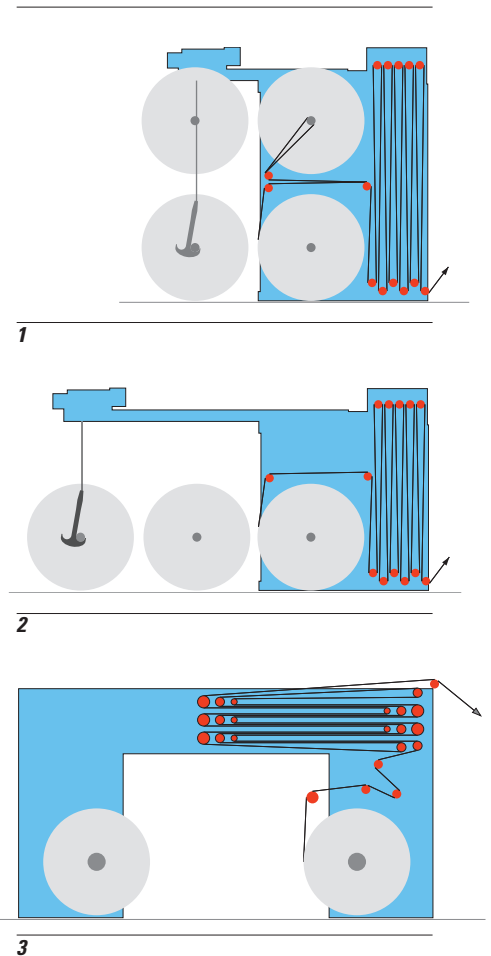

1- Roll-over-roll with vertical festoon.
2- Horizontal roll with vertical festoon.
3- Horizontal roll and festoon.

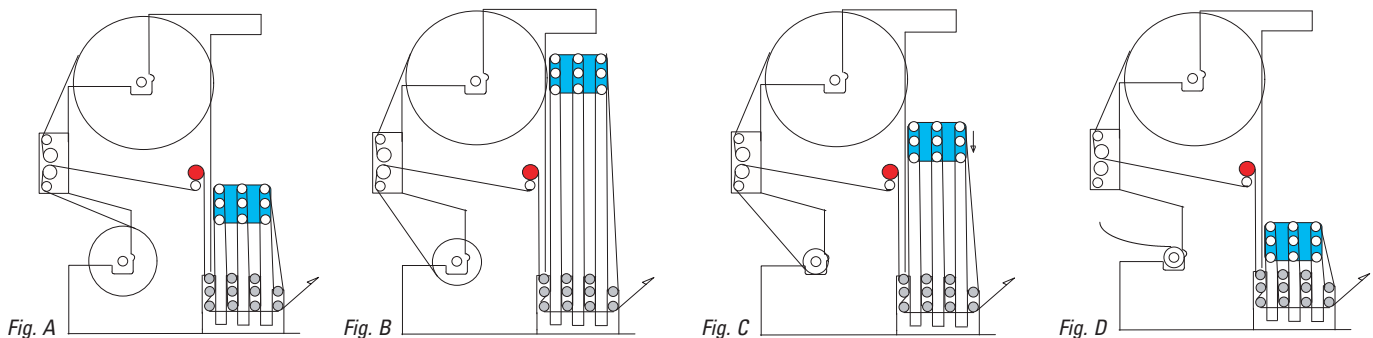

Splice pattern selection

PATTERN	WEB WIDTH		PAPER WEIGHT		PAPER GRADE		SPEED		
	< 1000 mm	1030 mm >	LOW	HIGH	UNCOATED	COATED	< 10	11 >	m/s
	< 40"	41" >					< 2000	2100 >	fpm
Straight	●	○	○	●	○	●	●	○	
V	●	○	●		●	○	●	○	
W		●	●	○	●	○	●	●	
All-in-one	●	○	○	●	●	○	●	○	

● **Normal practice**

○ **Possible use with care**

To achieve consistent splice efficiency of over 99% requires (a) optimum combination of tape and tab qualities; (c) correct splice preparation; and (c) a paster maintained and operated to ensure an efficient splice cycle

☞ Splice pattern selection should be appropriate to the paper grade, condition of roll, paper weight, web width, paster type and press speed. As these conditions are highly variable, this chart is only a general guide based on broad experience.

There are many variations of splice pattern in use today. The precise layouts of each pattern are normally provided by the paster supplier but they can often be optimised by discussing them with a specialist tape and tab supplier.

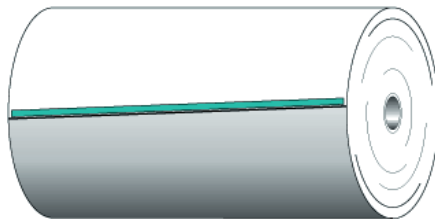

Straight cut

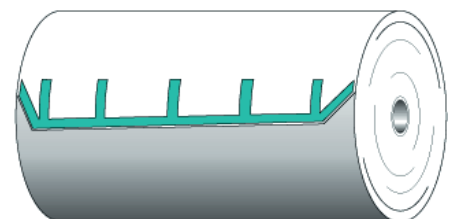

Flat V shape cut

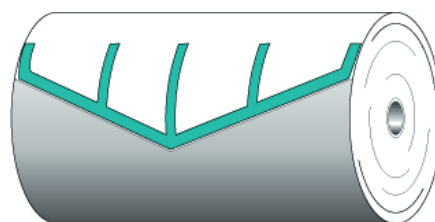

Symmetric V shape cut

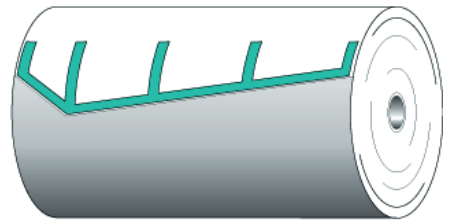

Asymmetric V shape cut



Double V shape cut

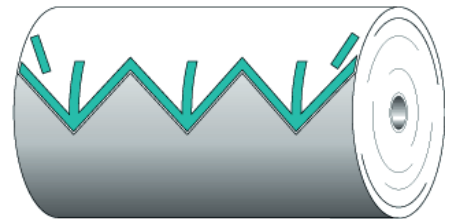

Multi V shape cut

W and V patterns

Recommended for use on any web width and particularly if the roll is deformed, paper is fragile or has a low weight.

For printers using W and V shapes it is a good idea to make a sheet metal template for common roll widths. The template should also show tape-free areas of acceleration belt(s) and position of folder slitter wheels.

The inner apex of the W pattern is a potential weak point, many printers have adapted their patterns to allow the tape to reinforce this point.

There are also several different methods used to secure the apex of the pattern.

(see pages 52 & 53 for best practice splice preparation)

Straight splice pattern

Most frequently used in commercial printing on coated papers and increasingly by news papers. It should be used with care when there are significant periods between preparation and the start of the paste cycle.

The space between the splice tabs needs to be selected in relation to paper strength and press speed to minimise creation of air pockets, that can lead to burst splices.

Recommendations:

- 100 mm (4") space between tabs for light or fragile papers.
- 150 mm (6") space between tabs for strong papers.

The splice can be at 90°, but many printers use a 1:10 angle to reduce the impact of splice preparation thickness as the splice passes through the press.

(see pages 54 & 55 for best practice splice preparation)

All-in-one pattern

All-in-one tapes are a recent development for straight splicing for both commercial and newspaper applications. These systems are simpler to prepare (no rupture tabs) and are more uniform (full roll closure). These tapes can be used on both core driven or belt driven pasters. The tape can be used when there are significant periods between preparation and start of paste cycle.

(see pages 56 & 57 for best practice splice preparation)

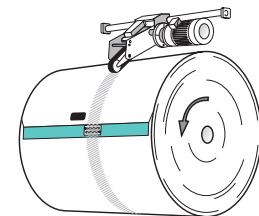
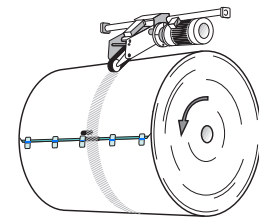
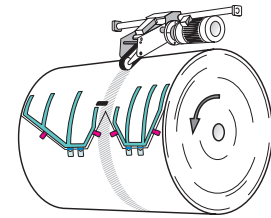

1- W splice pattern.

2- Straight splice pattern.

3- All-in-one splice pattern.



Correct knife cut and tail length.



New roll too slow.



Knife bounce or high web tension.

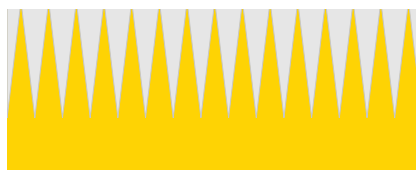

Incorrect speed match.

Every tail tells a story

The causes of many splice problems can be rapidly diagnosed by examining the splice tail. Many are simple and easy to fix by the paster operators or in-plant technicians with the aid of the user manual.

Splice tapes and tabs

Paster/Splicer type and drive

Tape and Tab selection	Flying belt drive	Flying core drive	Zero speed
1. Double sided PSA tape	● High tack	● High tack	● High or low tack *
2. Belt bridges	●		
3. Splice detection tabs	●	●	
4. Splice rupture tabs	●	●	
5. Folder exit detection tabs	●	●	●

PSA tape width

Paster/Splicer type	V & W	Straight	All-in-one
Flying paster	12 - 25 mm (0,5-1")	25 - 50 mm (1-2")	25-50 mm (1-2")
Zero speed splicer	-	12 - 25 mm (0,5-1")	-

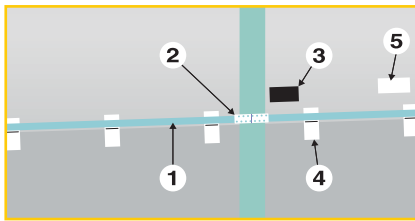

1

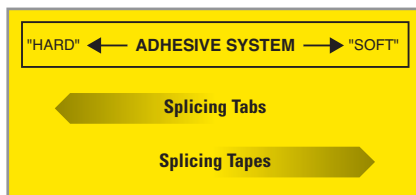

2

Tapes are available in a range of widths to suit varying splice characteristics. Under size tapes increase risk of splice failure and oversize tapes add avoidable cost. Check with your supplier to ensure using the correct width. *Use of low tack zero speed tape on a flying paster will lead to misssplice.

PSA tape with "Soft" repulpable adhesive

Double coated tapes for printing applications use a high tack pressure-sensitive adhesive on an acrylic base. The "soft" adhesive provides an aggressive high-tack and good surface contact is fundamental to adhesive performance:

Tabs with "Hard" adhesives

"Hard" adhesives are used for single coated papers converted into different types of tabs used in splice preparation. To achieve 99%+ splice success rate, tabs must complement the PSA tape with characteristics that include:

- Hard adhesive with high adhesion and high shear resistance on all paper grades.
- High temperature resistance <200°C (392°F) for heatset drying.
- Low oozing properties to allow the tape to remain on the roll for a certain time period.
- Suitable for precision conversion with die cuts/perforation to ensure constant properties, e.g. correct "tearing" action, specified tight tolerances.

Adhesive types

Repulpable tapes and tabs are normally recommended as best practice material selection because their adhesives have the highest functional splice performance (e.g. sheer and temperature resistance, tack level) with repulpability as a supplementary benefit. These adhesives are sensitive to temperature and humidity and need to be stored accordingly. Non-repulpable adhesive systems have a lower tack level and should be used with care at high speed. No special attention is needed for their storage. Frequently they do not comply with conditions for collection by paper recycling companies requiring their separation from the waste stream.

Liquid "wet" glue use has declined rapidly due to the difficulties of application and the risk of splice failure. In a number of countries it is also forbidden because of health risks.

Quality control

The specialised production process of PSA tapes means they generally have a high quality control to conform with ISO 9001 (and ISO 14000 environmental certification). It is also essential that tabs are designed and manufactured to the same high quality standards.

Tabs are often manufactured by companies without specialised knowledge of splicing technology and the required performance criteria for adhesion, die cutting and corresponding quality control.

1- Adhesive types for tapes and tabs.
2- Type of splice tapes and tabs.

1 Pressure Sensitive Adhesive (PSA) tape

Pastes the new web to the running web with sufficient adhesion to pass through the press, dryer and exit the folder without failure of the join. High tack adhesive tape functions equally well for zero speed and flying paster. Characteristics

- High tack to ensure instant initial grasp during the fraction of a second in which a splice is made.
- High shear to allow use of the narrowest tape width to minimise disturbance to press and folder.
- High temperature resistance for heatset drying.
- Colours, which make the application easier for the operator.
- Easy peel paper release liner to avoid accidental damage by tearing.
- Tape tearable by hand to eliminate potential damage from knife or scissors.



- Good surface contact is fundamental to adhesive performance: Paper must be dry, free from paper dust and have a minimum bond area temperature, of 15°C (59' F). Optimum adhesion requires pressure to be applied across the total width and length of the tape after positioning (if not significant bonding efficiency will be lost and risk of splice failure is very high).



- Use of low tack zero speed tape for a flying splice will lead to misssplice.

2 Belt bridges

Positioned in the path of the acceleration belt(s) over the top of PSA tape instead of leaving a gap in the tape. All-in-one systems use a special bridge tab to cover the splicing zone and fully close the roll. Characteristics

- Fully close the splice to prevent air pockets forming during acceleration.
- Provide a certain level of PSA contact during the splice.
- Perforations allow correct positioning.



- Do not use part of the PSA liner as a bridge tab because the liner will separate from the tape during acceleration and may cause a miss-splice.

3 Splice detection tabs

Two types (a) printed solid black for recognition by a photocell (correct density and consistency of printing are essential to ensure they are reliably detected) and (b) reflective for light sensor detectors.

4 Splice rupture tabs

These tabs are die cut and/or perforated to break instantly after the splice has been made to release the new roll for unwinding. They are also used to hold down the outer spire during rotation to prevent air pockets being formed (which can burst the splice preparation during acceleration). The number and type of tabs are determined by splice speed, paper grade and pattern shape. Characteristics: Roll closing and breakable

5 Folder exit detection tabs

Usually aluminium (bright or dull). In Europe there are not normally separated from pressroom waste because they are easily removed by filtration during repulping.

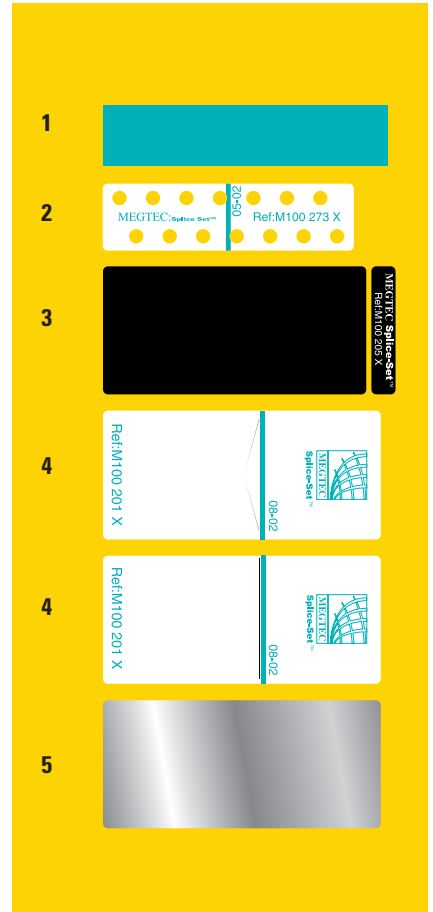

All-in-one tape systems

This new generation of repulpable tapes for splicing combines the function of rupture tabs for roll closing and double-sided PSA tape for automatic flying splice operations into one tape. No rupture tabs are required.

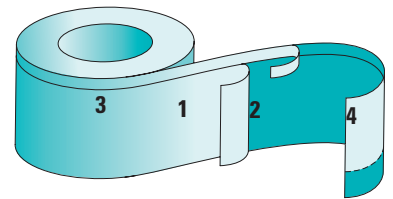

- 1 Release liner
- 2 Application adhesive
- 3 Roll closing adhesive
- 4 Flying splice adhesive

Splice tails

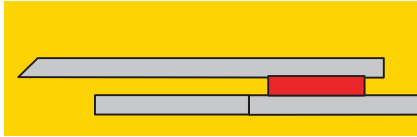

Normal overlap splice with tail.



Splice tail secured with a narrow strip of PSA tape.

Apply glue to securely hold-down the tail during its journey through the press and folder.

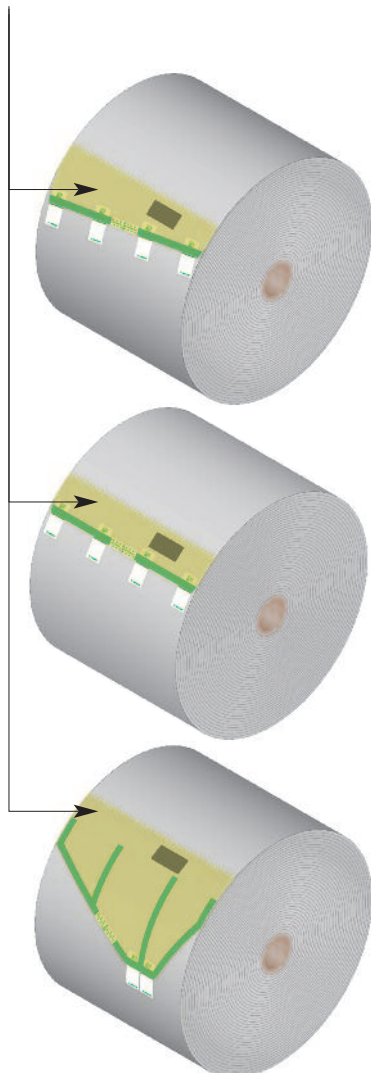

The effective tail length is determined by the type of splice pattern.

Many users do not consistently achieve their paster's capability to deliver a short tail (some flying pasters can deliver very short splice tails of around 100 mm / 4"). This often happens when operators are not made aware of the importance of short tail length, or if best practice splice preparation is inconsistently applied.

Tail length

All zero and flying splices normally have tails. Their length should be short to minimise the probability of the tail being cut loose by the folder cutting cylinder (which can trigger a jam detector or cause a folder jam). Flying paster tail length is influenced by the splice pattern, position of splice detection tab and the accuracy of speed synchronisation between the new and running rolls. Some zero speed splicers can reduce the tail length to the width of the tape (this technique increase preparation time by up to 1 minute).

Secure the tail

A big advantage of flying pasters is that the splice can be angled across the web to reduce the impact of the splice running through the press and thickness build-up at the folder tucker blade. However, an angled splice leaves part of the tail longer than the minimum cut length. Many printers reduce this risk by securing the loose tail.

- Some users apply a second narrow strip of PSA (or glue) to hold down the tail for sensitive production, e.g. sheeter or use an aerosol glue (type 3M Post-it) to secure the loose area.

Splice tab position = cutting point

When preparing rolls there are only two simple things to remember:

- The "relative" length of the tail (distance between tab and cut) is determined by the position of the splice detection tab. The same relative tail length is possible for all splice patterns.
- The "effective" tail length (distance between cut and end of splice pattern) is determined by the type of splice pattern used.

Splice tab position

Irrespective of what splice pattern is used, the distance between the end of the splice pattern and the cut web is always the same providing the splice detection tab is correctly positioned. The tab is always in the same relative position for all splice patterns. The effective tail length is determined by the type of splice pattern.

Detector position

A constant tail length error can be caused by a change in the relative position and/or angle of the splice tab detector.

Tail position

On flying pasters the tail is in a constant position, on zero speed the position changes with every roll.

Paster makeready

PASTER OPERATION SAFETY

! *Different paster types and models have their own specific operation. Therefore this general guide can under no circumstances replace the paster supplier's instructions. Before operating the paster, all staff involved must know the manufacturer's safety regulations, operating instructions and maintenance procedures.*

Paster makeready

- Set roll width (adjust width between paster arms to roll width + clearance specified)
- Core waste : This is the pre-set amount of paper to be left on the core at time of splicing. This length of paper is determined on the basis of (a) minimum reserve to avoid web running off roll and consequent press stop and (b) the last wraps around the core may not be suitable for printing due to wrinkles or embossing.
- Set low start-up tension setting (to minimise risk of web break at low speed)
- Web-up paster after roll is loaded following the paster manufacturer's instructions.
- Ensure web guide is centred.
- Ensure web cocking device is in neutral position. Some zero speed and flying pasters can cock either the festoon or outlet roller. This is used to compensate for deformed rolls. It is essential that this device is in a neutral position when not required as otherwise it will create massive instability in the running web.

Set running tension paster and infeed

- !** Experience identifies these starting points to develop optimum settings on each press (in conjunction with those of the manufacturer).
- Always reset tension when changing paper weight.
 - Set low start-up tension level (to minimise risk of web break at low speed).
 - Fine tune tension during makeready and running.
 - Record settings for each paper and web width for faster future set-up with less waste.

- !**
- Too high tension causes wrinkles, increased web break risk and can change print length.
 - Too low tensions causes web wander.

Half and part roll widths

Part roll widths generally run better in the centre (if the folder permits). For twin web inline configurations the half web should be run in the lower position to print in the second set of units to avoid running a part web over air turns and to minimise tension variations.

Some zero speed splicers use parallel festoon rollers (Fig. A). Most splicers use tapered rollers to self-centre the web and provide better tension on web edges (Fig. B).

If the roll cannot be run in the centre (for some 2-web productions) the rollers will need to be taped to avoid web wander (Fig C). The dancer rolls can be cocked on some models.

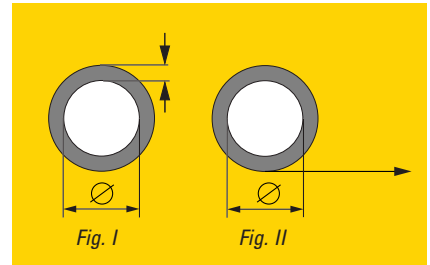

Core waste is set either as (Fig I) radial thickness or (Fig II) linear length. To minimise either having too little core waste or too much, these settings can be changed when the press changes from a very thick to a very thin paper or vice versa. Attention, the external diameters of cores are variable.

Commercial start-up tension settings		
Paster	40-120 gsm	120-150 N/m (0,68-0,86 pli)
Infeed	30-60 gsm	= (...gsm x 10 x 90 %) = ... N/m
	60-90 gsm	= (...gsm x 10 x 80 %) = ... N/m
	90-120 gsm	= (...gsm x 10 x 70 %) = ... N/m

Newspaper start-up tension settings		
Paster	70-90 N/m	0,4 - 0,5 pli
Infeed	200 N/m	1,142 pli
1 N/m = 0,00571 pli (pounds linear inch)		

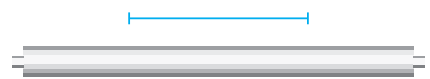

Fig. A. Parallel festoon rollers.

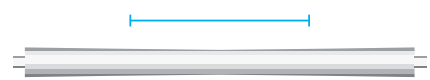

Fig. B. Tapered rollers to self-centre the web.

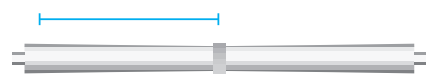



Fig. C. Off-centre half web requires tapered rollers to be taped.

Roll to web processing steps

ON PASTER	OFF-PASTER
No roll handling system Roll next to paster	If roll handling system installed Roll on preparation station
1. Remove end covers and core plugs inspect and test with Schmidt Hammer	Same
2. Record roll N° & bar code (if system fitted)	same
3. Load roll on to splicer (or hoist for upper roll on RoR types)	Weigh roll (if system fitted)
4. Remove brown wrapper, weigh on scale & dispose	same re-weigh & dispose
5. Slab off white waste, weigh on scale & dispose	same re-weigh & dispose
6. Prepare splice Rotate roll to avoid dust falling on to tape Set cocking roller if necessary to compensate for with uneven rolls	same (if a flying paster) same Auto loading on to paster
7. Splice cycle	same
8. Remove core/part roll  The butt roll must be supported as the chucks are retracted.	same or automatic



1





2

Splice success rate and web break frequency are significantly related to the quality of preparation. If splice failures and web breaks are high, or increase, it is generally the result of one or a combination of (a) poor preparation, (b) poor splice materials (tapes & tabs), (c) incorrect splice pattern for paper type, speed and width (d) poorly set or maintained equipment.

Splice preparation

Preparation can be carried out in different places (on the paster or at roll preparation station) according to equipment installed and working methods. There are many variations of roll and splice preparation, the two described here are selected as references to provide the highest splice efficiency.

-  Premature removal of the wrapping increases the risk of dimensional instability from atmospheric variations, and accidental damage to the white paper.
-  On-paster preparation is recommended if there is no roll handling system installed as this minimises damage, waste and is ergonomically more efficient.

Rolls transport to the paster

-  Best practice roll handling avoids damage which frequently leads to excessive paper waste and web breaks.

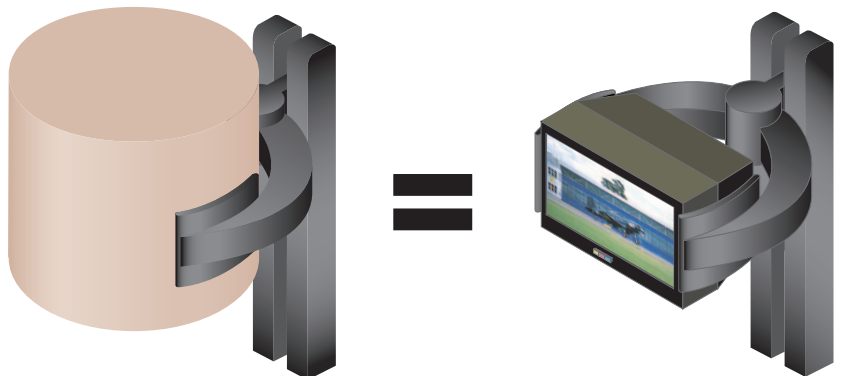



3

- 1- On paster preparation.
2- Off paster preparation.
3- A paper roll costs the same as a large colour TV!

Best practice preparation

SPLICE PREPARATION TOOL KIT
• Schmidt hammer to test rolls for soft spots
• Flat bladed knife for removing roll end covers
• Roll slitter for stripping (available from most paper suppliers)
• Scissors (to cut off splice “ears”)
• Sharp knife for cutting out damaged sections
• Sandpaper or powered sanding disc to smooth out damaged areas of the roll
• Template (sheet metal) particularly useful for V and W patterns, for principal web widths. Marked with position of acceleration belt.
• Broad tipped felt marker to draw around template (not ball point pen which cuts into & weakens paper)
• PSA tape applicator
• Good lighting where rolls are inspected and prepared for splicing.
• Roll report sheet for monitoring paper data and splice/web break failures.

1 Remove end covers (shields)

- 
 - If a knife is used, care should be taken not to penetrate the roll end. A broad bladed knife helps reduce this risk.
- 
 - The cutting action with the knife should always be away from the person using it to minimise the risk of injury if the knife slips. Always return the knife to a scabbard when not in use.
- 
 - Inspect the roll ends for damage.
 - Remove core plugs (if fitted) and inspect core for damage:
 - For pasters with chucks, the outer 10-15 cm (4-6”) must be in good condition.
 - For pasters with shafts, the core must not be crushed or blocked.

A Schmidt hammer can be used to test rolls for soft spots.

2 Record information/read bar code and weigh (if systems installed)

At this point, the roll number and other information should be recorded either manually (most paper mills provide peel-off labels which can be stuck on to a report sheet) or automatically (via. the bar-code) into a data log or other information system.

This information provides essential data on paper use and allows rolls to be traced in the event of paper problems.

Radio frequency tags (RF) are a new roll tracking technique being introduced by some mills and printers. The tag is inserted into the roll core and can be automatically read by detectors in the store, on fork lifts and roll transporting devices and at pasters to give the status of all rolls in the plant at all times.



1



2

- 1- Remove end covers with a broad bladed knife.
- 2- Read bar code or peel-off label.

3 Load roll on to paster: best practice and safety first

! Before operating the paster, all staff must know the manufacturer's safety regulations and operating instructions.

- Arm rotation safety: Before splicing, and during manual arm rotation, the operator must verify that rotation path is clear of personnel and foreign objects.
- Emergency stop devices: All staff must know their location and function.

Chuck pasters

! Roll loading safety, check :

- Roll arms are adjusted to the correct width for the roll being loaded plus supplier's tolerance. For pasters without any form of assisted loading, it is a good idea to paint reference lines on the floor for common web widths to allow better line-up of rolls before they are moved into the arms. Edge damage is common during loading from collisions with paster arms or chucks and causes avoidable paper damage.
- Make sure chucks are fully retracted and free of debris before loading and roll brake switched on.
- Verify chucks are fully inserted on both sides. Risk is that roll could come free of chucks to create a potentially serious accident, damage to roll and paster.
- Chuck jaws are fully expanded into core. If soft cores are used there is a risk that the chucks will settle into core. If chucks do not provide continuous automatic expansion, then the chucks should be checked for expansion just prior to start of splice cycle.
- If manual expansion tools are used (T-wrench, air guns) ensure they are removed and replaced in their storage rack immediately after they have been used. High risk of injury.

- \$**
- Make sure that the roll unwind direction is correct before loading (marked on roll end).
 - Lost time to unload roll, rotate and re-load it creates risk that roll is available too late for splice.

Expanding shafts

! Expand the shaft before the roll is loaded on to the paster/hoist otherwise the roll will be off centre.

\$ Off centre rolls generate vibrations and tension variations during unwinding causing increased risk of web break, creasing and miss register.

Hoists (used in conjunction with shafts). For splicers with roll-over-roll design, make splice preparation on hoist.

!

- Follow supplier's procedures to avoid safety and roll damage risks.
- Ensure shaft is locked into position in paster.

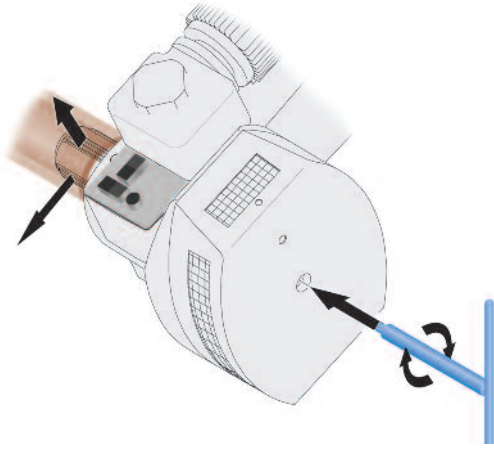

1

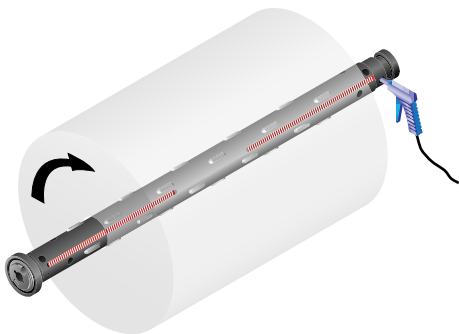

2

1- Ensure chucks are fully retracted and free of debris before loading and roll brake is switched on.

2- Always expand air shaft before roll is loaded.

4 Removal of wrapper

- Use plastic/wooden roll stripper when removing the belly wrapper (do NOT use a knife).
- Dispose wrapper with brown waste.

- Removing the belly wrapper with a knife is less controllable and can result in excess strippings.



Use a roll stripper to remove the belly wrapper.

5 Slab off white waste, record & dispose

- Pull individual wraps from the roll, inspecting the edges and belly for damage as you do so. If both are OK, prepare the splice.
- If further stripping is needed, tear the top layers by hand before introducing the stripping tool. Once the roll is damage free, prepare the splice.

Experience shows that some edge and side damage does not always require stripping to the bottom of the damage. This can often be treated by carefully cutting out with a sharp knife and/or sanding of the area. The press operator should be informed of the problem so that he can slow down the press and nurse the damaged web through the press. Applying a lubricant to damaged area may assist passage through the press.

- Failure to identify end damage may result in a web break during production.
- Risks to accidental damage to the white paper are increased.
- Over zealous use of the stripper will result in unnecessary waste.

Frequently more layers are stripped off than are really necessary. It is important to remember that much more paper can be saved at the top of a roll compared with near the core, e.g. 5 mm (0,25") at the top of a roll is equivalent to 5 cm (2") at the core!

STRIPPING WASTE CALCULATION CHART

Stripping waste as % of total paper on roll

DEPTH OF DAMAGE	ROLL 1000 MM/40"	ROLL 1250/50"
100 mm 3,94"	36,36%	29,63%
90 mm 3,54"	33,09%	26,90%
80 mm 3,15"	29,74%	24,12%
70 mm 2,76"	26,30%	21,28%
60 mm 2,36"	22,79%	18,40%
50 mm 1,97"	19,19%	15,46%
45 mm 1,77"	17,36%	13,97%
40 mm 1,57"	15,52%	12,47%
35 mm 1,38"	13,65%	10,96%
30 mm 1,18"	11,76%	9,43%
25 mm 0,98"	9,85%	7,89%
20 mm 0,79"	7,92%	6,34%
15 mm 0,59"	5,97%	4,77%
10 mm 0,39"	4,00%	3,19%
5 mm 0,20"	2,01%	1,60%

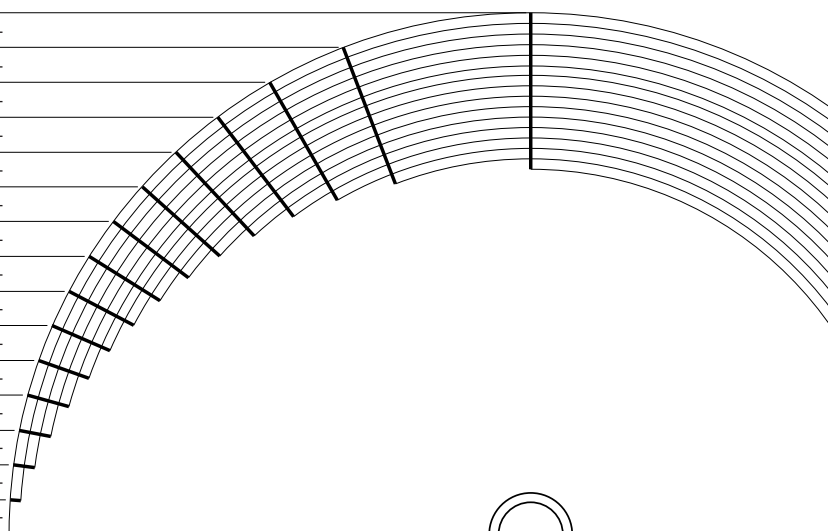

V&W patterns

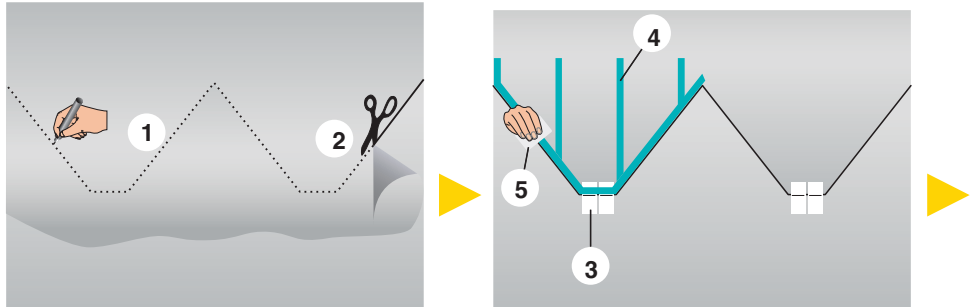
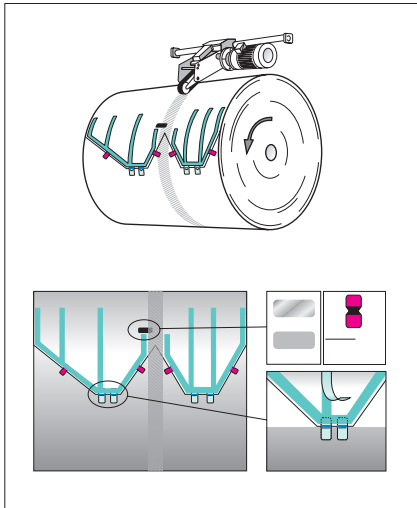

6.1 Flying paster splice preparation

Apply the brake as required to stop the roll rotating during preparation.

Cut out the splice profile in the first paper layer (spire)

Draw around template with broad tipped felt marker **1** and cut-out (or tear-out) **2**.

Do not use a ball point pen which cuts into and weakens paper.

Expel air between the outer and inner spires so that they lie smoothly

Wrinkles cause tearing and separation of the top layer from the surface during acceleration.

Use rupture tabs to close the roll system **3**.

The distance between tabs (100-150 mm/4-6") is related to paper weight and press speed. Outer tabs should be 25 mm (1") from the roll edge.

- Do not apply tabs too tightly or they may break in advance of splice.
- Always close the top of the splice pattern to prevent creating air pockets which can cause splice failure.
- Incorrect rupture tab position increases breaking strength and may result in a failure to open.
- Use line printed on the tab to position adhesive-free zone under the line pointing to the inner spire of the roll for easy opening at pasting.

Apply the tape **4** along the splice profile 2mm (0,08") from the edges on all three side

- Do not remove protective cover of tape. Optimum adhesion requires pressure to be applied across the total width and length of the tape after positioning. **5** Use a tape applicator (plastic card) to assure correct pressure. The inner apex of the W pattern is a potential weak point, many printers have adapted their patterns to allow the tape to reinforce this point.
- Do not allow tape to overhang the roll edges.
- Do not overlap tape **6** as this creates thickness peaks reducing the adhesive contact surface in a splice area; thick splices may also cause folder jams.
- Do not apply tape in the acceleration belt area width +10 mm/0,4" unless using a bridge label to protect the tape (otherwise splice preparation will be torn off by acceleration belt).
- Do not apply tape/tabs in the path of folder slitter wheel path (possible web break of a ribbon).

Several different nose tab designs are available.

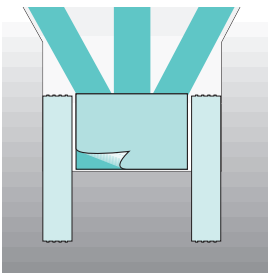

USA nose tab.

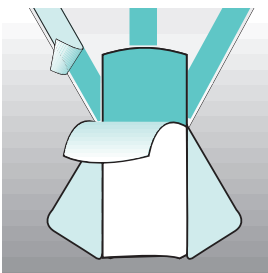

European nose tab.

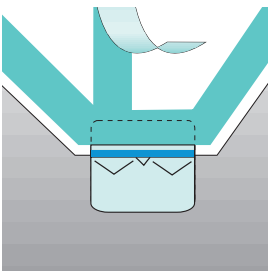

Double rupture nose tab.

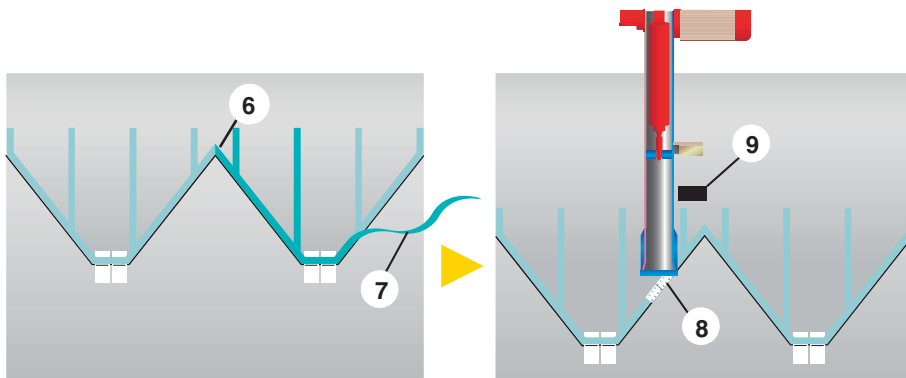

Remove PSA tape protective strip 7.

Apply belt bridge tab(s) 8.

If belt acceleration, apply belt bridge tab(s) in path of acceleration belt(s), make sure the tape width is fully covered.

Apply detection label correctly positioned for optimum tail length 9.

Apply aluminium folder exit detection label if required.

Rotate roll to avoid dust and moisture condensation falling on to tape.



- Dust and condensation on the tape surface reduces its adhesive qualities. If possible, only remove the complete protection strip/liner from the adhesive just prior to the splice cycle.
- Set lateral position of new roll to align it with position of running roll to avoid the high risk of splice failure or web break.



- Splice failure, web break, paper waste, press down time, folder jam.
- Splice failure (poor adhesion)
- Roll opens before splicing (missplice)
- New roll does not open (no splice, press emergency stop, re web)
- Folder jam from too thick splice.

Technique to use with discretion.

Applying grease to the edges of the web, alongside of the splice zone should be done with care. The purpose is to avoid roll edges sticking to blanket at splice point. Consequences are accumulation of grease and paper dust on splice arm and splice roller which may reduce its surface life.

Do not overlap tape



Overlapped tape creates thickness-peaks reducing the adhesive contact surface in a splice area; thick splices may also cause folder jams. e.g. overlap risk on a W pattern.

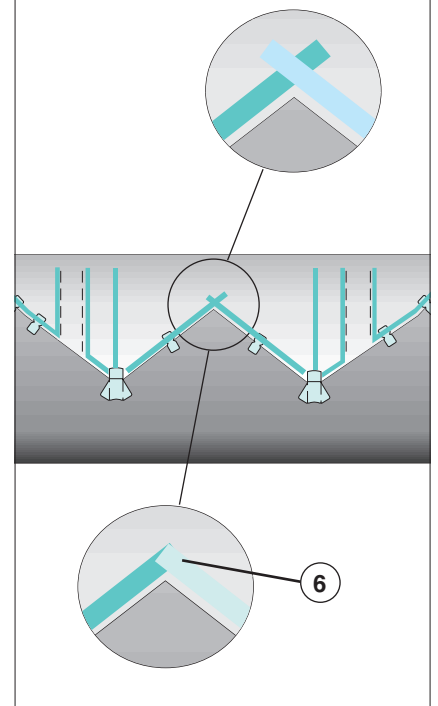

Straight pattern

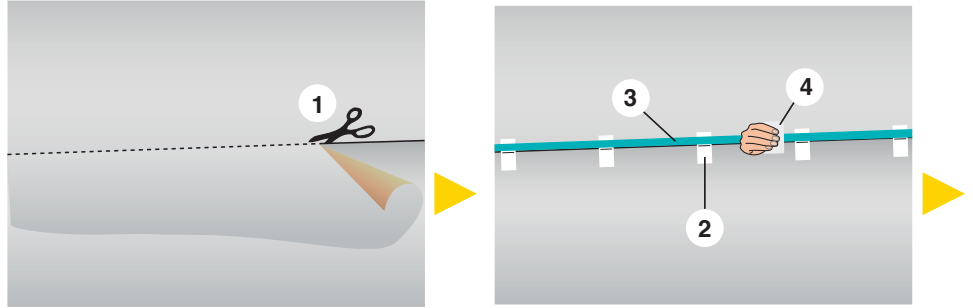
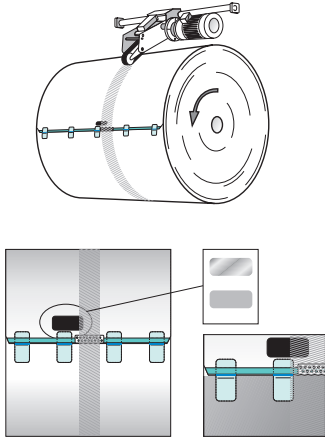

6.2 Flying paster splice preparation

Apply the brake as required to stop the roll rotating during preparation.

Cut out the splice profile in the first paper layer (spire) ①

Bend the first paper layer (spire) and slit along the folded edge.

Expel air between the outer and inner spires so that they lie smoothly

⚠️ Wrinkles cause tearing and separation of the top layer from the surface during acceleration.

Use rupture tabs to close the roll system ②.

The distance between tabs (100-150 mm/4-6") is related to paper weight and press speed. Outer tabs should be 25 mm (1") from the edges.

- ⚠️ • Do not apply tabs too tightly or they may break in advance of splice.
- ⚠️ • Always close the top of the splice pattern to prevent creating air pockets which can cause splice failure.
- ⚠️ • Incorrect rupture tab position increases breaking strength and may result in a failure to open.
- ⚠️ • Use line printed on the tab to position adhesive-free zone under the line pointing to the inner spire of the roll for easy opening at pasting.

Apply the tape ③ along the splice profile 2mm (0,08") from the edges on all three sides.

- ⚠️ • Do not remove protective cover of tape.
Optimum adhesion requires pressure to be applied across the total width and length of the tape after positioning. Use a tape applicator (plastic card) to assure correct pressure ④.
- Do not allow tape to overhang the roll edges.
- Do not apply tape in the acceleration belt area width +10 mm/0,4" unless using a bridge label to protect the tape (otherwise splice preparation will be torn off by acceleration belt).
- Do not apply tape/tabs in the path of folder slitter wheel path (possible web break of a ribbon).

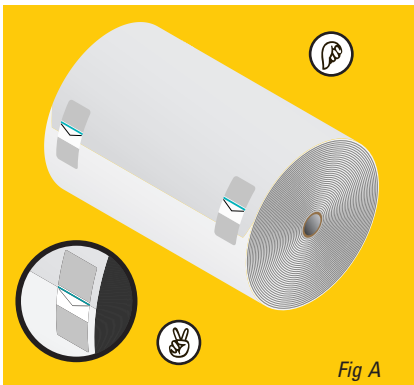
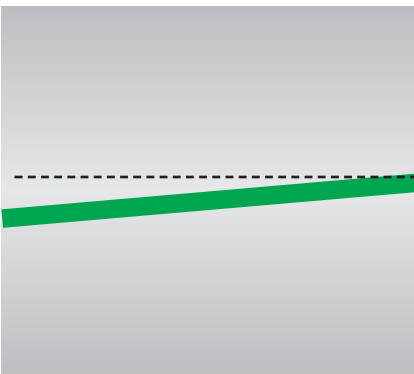
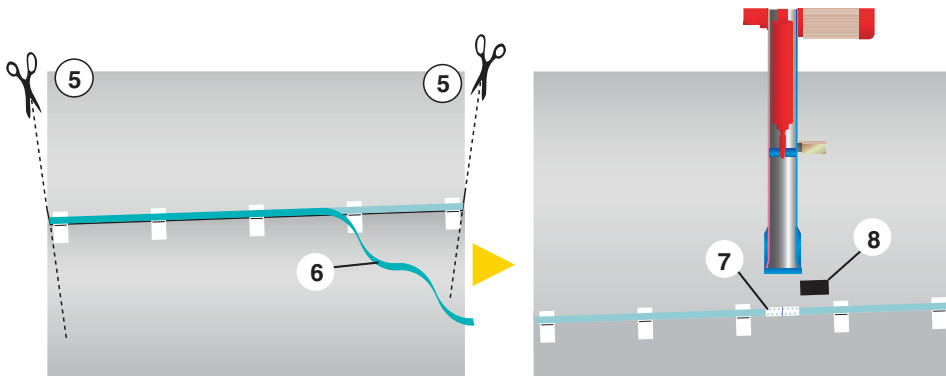

Fig A



1

1- Straight splices can be at 90°, but many printers use a 1:10 angle to reduce the impact of splice preparation thickness as the splice passes through the press.



Use scissors to cut off "ears" of leading edge next to the external tabs to improve edge profile ⑤.

Belt driven pasters

Remove PSA tape protective strip ⑥ and apply belt bridge tab in path of acceleration belt, make sure tape width is fully covered ⑦.

- ⑦ • Do not use tape liner cover because its adhesion is so low that it will be torn off by the belt which will then destroy the splice preparation.
- ⑧ • Holes in belt bridge tab allow correct positioning on to exposed PSA tape, the width of which must be fully covered.

Apply detection label correctly positioned for optimum tail length ⑨.

Apply aluminium folder exit detection label if required

Release paster brake. Rotate roll to avoid dust and moisture condensation falling on to tape.

- ⑩ • Dust and condensation on the tape surface reduces its adhesive qualities. If possible, only remove the complete protection strip/liner from the adhesive just prior to the splice cycle.

Set lateral position of new roll to align it with position of running roll to avoid the high risk of splice failure or web break.

- ⚠ • Splice failure, web break, paper waste, press down time, folder jam.
- Splice failure (poor adhesion)
- Roll opens before splicing (misssplice)
- New roll does not open (no splice, press emergency stop, re web)
- Folder jam from too thick splice

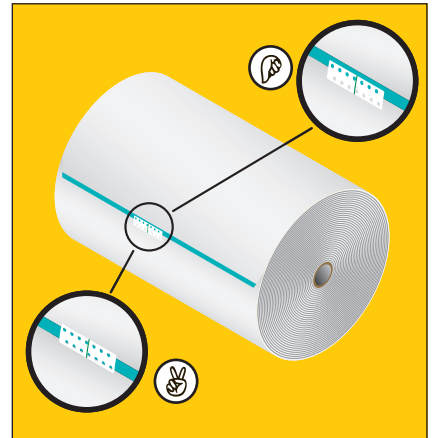

- ⑧ Holes in belt bridge tab allow correct positioning on to exposed PSA tape, the width of which must be fully covered.

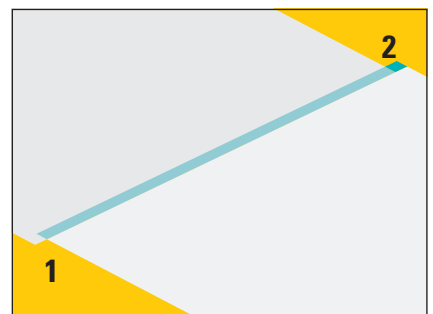

- ⑪ 1 Overlapped paper edge sticks to ink build-up on blanket edge tearing the web.
- ⑫ 2 Exposed adhesive will stick on to rollers or blanket causing a break.

Technique to use with discretion

Applying grease to the edges of the web, alongside of the splice zone should be done with care. The purpose is to avoid roll edges sticking to blanket at splice point. Consequences are accumulation of grease and paper dust on splice arm and splice roller which may reduce its surface life.

Zero speed

6.4 ROLLING NIP SPLICE PREPARATION

A Open appropriate preparation bar

Pull enough paper from new roll to reach past the preparation head and apply holding brake. Place the web against the prep bar where the vacuum will hold it in place. Align the edge of the web with the running roll. Make sure web is square and uniformly tensioned.

B Trim off the excess web

Use a sharp knife using the prep bar edge as a guide. Apply the splicing tape across the full width of the web 2 mm from the paper edges on all three sides. Do not allow tape to overhang edges. Optimum adhesion requires pressure to be applied across the total width and length of the tape after positioning. Trim off corners and leading edges to help allow for any small misalignment of webs at splicing.

C Transfer to nip roller

Re-check alignment of web and ensure it is square and of uniform tension.



- If the paper is stiff or has a curl away from the nip roll it may be necessary to roll the material so that it conforms to the curvature of the nip roller.

- It is essential that any uncovered holes in the vacuum bar are sealed off with tape otherwise a failed splice may occur.
- Any build-up of tape or paper on nip rolls may prevent a good seal at time of splice.

Remove the complete protection strip/liner from the adhesive. Clean off any excess adhesive from the prep bar.

D Close the splice head

Rotate the nip roller in the direction that the web will be running until it is taut.



- Splice failure, web break, paper waste, press down time, folder jam.
- Splice failure (poor adhesion)

Key preventative maintenance for pasters and splicers

It is essential that the maintenance procedures supplied by the manufacturer of your equipment are completely followed to ensure optimum performance, avoid safety risks and break downs to enhance the longevity of equipment. Substitution of recommended consumable parts (drive belts, brake pads, foam rollers) is not recommended as these alternatives rarely have the same specifications and frequently cause operating problems and have a short life.

The following table is a summary of the problems that can occur when equipment is not correctly cleaned, set and maintained.

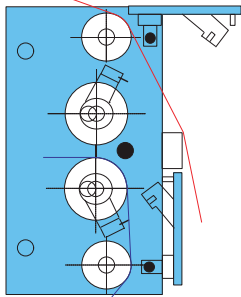

1

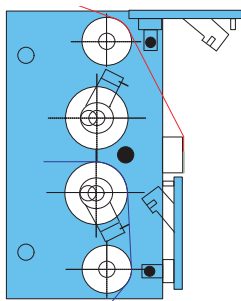

2

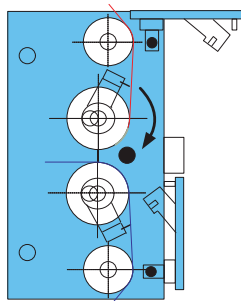

3

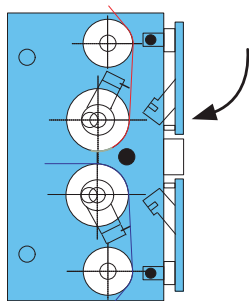

4

- 1- Side view of preparation head.
- 2- Trim off the excess web and apply the splicing tape.
- 3- Transfer to nip roller.
- 4- Close splice head and rotate nip roller in web direction until taut.

Setting and maintenance	Burst	Fail	Mis	Break	Flying	Zero
1 Debris build up on roller edges				●	○	○
2 Sensor defective or dirty		●	●		○	○
3 Roll not up to speed		●	●		○	
4 Roll will not go to splice position (paster status problem)		●			○	
5 Tension/drive belts: Incorrect tension, burred, worn	●	●	●	●	○	○
6 Pasting brush/roller dirty, worn, incorrect pressure (see also 7)		●	●		○	
7 Knife cut too early (see also 10)		●	●		○	
8 Knife cut too late (see also 10)		●	●		○	
9 Knife failed (see also 10, 17)		●			○	
10 Improper adjustment or malfunction of paster carriage		●	●		○	
11 Roll runs off core		●			○	○
12 Incorrect brake load/tension setting			●	●	○	○
13 No low tension makeready setting (start-up break)				●	○	○
14 Press stops in splice cycle (no web break but no splice)		●			○	○
15 Press speed change during paste cycle		●	●	●	○	
16 Oscilation of compensating roller (pumping)			●	●	○	○
17 Erratic tension near end of roll			●	●	○	○
18 Excessive tension during splice			●	●	○	○
19 Brakes fail to transfer correctly		●	●	●	○	○
20 Air supply failure cause loss of tension				●	○	○
21 Drops of oil, water, ink falling on to web				●	○	○
22 Overpacked blanket explodes splice in printing unit			●		○	○
23 Zero speed splicer head rollers out of alignment		●	●			○
24 Faulty zero speed dancer operation						
Web break during Deceleration				●		○
Dancer cylinder ports closed	●			●		○
Chain sprockets worn	●			●		○
Dancer brake malfunction	●	●		●		○
Web break during Splice: Insufficient air pressure		●		●		○
Web break during Acceleration	●			●		○
Dancer rollers out of alignment		●		●		○
Dancer bottoms out:				●		○
Inadequate air pressure on dancer	●	●		●		○
Inadequate acceleration signal (air flow volume or electrical signal)	●	●		●		○
Leaking dancer cylinders	●	●	●	●		○
Dancer not at maximum position prior to splice (runs-out of paper)	●	●		●		○
Dirty or glazed acceleration roller	●	●	●	●		○
Loose, dirty or worn acceleration belt	●	●	●	●		○
Dancer does not fill prior to splice	●	●	●	●		○
Dancer tension too low	●	●	●	●		○
Brakes set too tight	●			●		○
Air leaking from brake interferes with running roll solenoid			●	●		○
If dancer fills out before or after splice				●		○
Speed signal incorrect				●		○
Incorrect brake transducer adjustment	●	●	●	●		○
Incorrect or faulty dancer POT/encoder setting	●	●	●	●		○



BEST PRACTICE

Aylesford Newsprint

Aylesford Newsprint is a dedicated manufacturer of premium quality newsprint. Its "Renaissance" brand is widely used by many major European newspaper publishers. The mill specialises in 100% recycled newsprint of exceptional runability and superior printability — brighter, cleaner and with high opacity. All products are made exclusively by recycled paper using highly skilled staff operating the most advanced technology available. The company's continuous improvement programme helps ensure the attainment of the highest operational and environmental standards. Aylesford Newsprint is jointly owned by SCA Forest Products and Mondi Europe who bring a wealth of experience in quality paper manufacture.

www.aylesford-newsprint.co.uk

Kodak

Kodak GCG (Graphics Communications Group) provides one of the broadest product and solutions portfolios available in the graphic arts industry today, including a wide range of conventional lithographic plates and Computer to Plate solutions; Kodak GCG branded graphic arts films, digital, inkjet, analogue and virtual proofing products, as well as digital printing solutions and colour management tools. Kodak GCG is a leader in prepress technology and have received 16 Graphic Arts Technology Foundation (GATF) InterTech Technology Awards. With headquarters in Rochester, NY, USA, the company serves customers around the globe with regional offices in the United States, Europe, Japan, Asia Pacific and Latin America.

www.kodak.com

manroland

manroland AG is the world's second largest printing systems manufacturer and the world's market leader in web offset. manroland employs almost 8 700 people and has annual sales of some Euro 1,7 billion with an export share of 80%. Web fed and sheetfed presses provide solutions for publishing, commercial, and packaging printing.

www.man-roland.com



MEGTEC Systems is the world's largest supplier of weblines and environmental technologies for web offset printing. The company is a specialised system supplier for roll and web handling (loading systems, pasters, infeeds) and web drying and conditioning (hot air dryers, oxidisers, chill rolls). MEGTEC combines these technologies with in depth process knowledge and experience in coldset and heatset printing. MEGTEC has manufacturing and R&D facilities in the US, France, Sweden and Germany, China and India along with regional sales, service and parts centres. MEGTEC also provides energy and efficiency consulting and machine upgrades.

www.megtec.com



Muller Martini a globally active group of companies is the leader in the development, manufacture and marketing of a broad range of print finishing systems. Since its foundation in 1946 the family-owned business has focused exclusively on the graphic arts industry. Today, the company is segmented into seven operating divisions: Printing Presses, Press Delivery Systems, Saddle Stitching Systems, Softcover Production, Hardcover Production, Newspaper Mailroom Systems and OnDemand Solutions. Customers rely on a worldwide manufacturing, sales and service network of approximately 4 000 employees. Subsidiaries and representatives provide Muller Martini products and services in all countries of the world.

www.mullermartini.com



Nitto Denko Corporation is one of the world's specialist suppliers of polymer processing and precision coating. The company was formed in Japan in 1918 and employs 12 000 people all over the world. Nitto Europe NV is a subsidiary, which was founded in 1974 and is the group's leading supplier to the paper and printing industries with products like repulpable double-coated adhesive tapes for splicing systems. Nitto has also become the reference supplier to offset and gravure printers worldwide. Nitto Europe NV is ISO 9001 certified.

www.nittoeurope.com, www.permacel.com, www.nitto.co.jp



QuadTech is a worldwide leader in the design and manufacture of control systems that help commercial, newspaper, publication and packaging printers improve their performance, productivity and bottom line results. The company offers an extensive range of auxiliary controls, including its best-selling register guidance systems (RGS), the award-winning Color Control System (CCS) and the widely-known Autotron. QuadTech, founded in 1979, is a subsidiary of Quad/Graphics and is based in Wisconsin, USA. The company was ISO 9001 registered in 2001.

www.quadtechworld.com



SCA (Svenska Cellulosa Aktiebolaget) is a global consumer goods and paper company that develops, produces and markets personal care products, tissue, packaging solutions, publication papers and solid wood products. Sales are conducted in 90 countries. SCA has annual sales in excess of SEK 101 billion (c. € 11 billion) and production facilities in more than 40 countries. SCA had approximately 51 000 employees at the beginning of 2007. SCA has a range of high grade, customised publication papers for newspapers, supplements, magazines, catalogues and commercial printing.

www.sca.com, www.publicationpapers.sca.com



Sun Chemical is the world's largest producer of printing inks and pigments. It is a leading provider of materials to packaging, publication, coatings, plastics, cosmetics, and other industrial markets. With annual sales over \$3 billion and 12 500 employees, Sun Chemical supports customers around the world and operates 300 facilities throughout North America, Europe, Latin America and the Caribbean. The Sun Chemical Group of companies includes such well-known names as Coates Lorilleux, Gibbon, Hartmann, Kohl & Madden, Swale, Usher-Walker and US Ink.

www.sunchemical.com, www.dic.co.jp



Trelleborg Printing Blankets is a product area within Trelleborg Coated Systems. Trelleborg is a global industrial group whose leading positions are based on advanced polymer technology and in-depth applications know-how. Trelleborg develops high-performance solutions that seal, damp and protect in demanding industrial environments. Trelleborg is represented in the printing industry with its brands Vulcan™ and Rollin™. With the market knowledge grown over many years combined with innovative technology, patented processes, vertical integration and total quality management, servicing 60 countries on five continents, both brands can be considered among market leaders worldwide, providing offset printing blankets for the web, sheetfed, newspaper, business forms, metal decorating and packaging markets. Its European production sites are certified with ISO 9001, ISO 14001 and EMAS certifications.

www.trelleborg.com



www.wocg.info **e-TOOLBOX**

Members

www.kodak.com

www.man-roland.com

www.megtec.com

www.mullermartini.com

www.nittoeurope.com, www.permacel.com, www.nitto.co.jp

www.quadtechworld.com

www.sca.com, www.publicationpapers.sca.com

www.sunchemical.com, www.dic.co.jp

www.trelleborg.com

In association with